

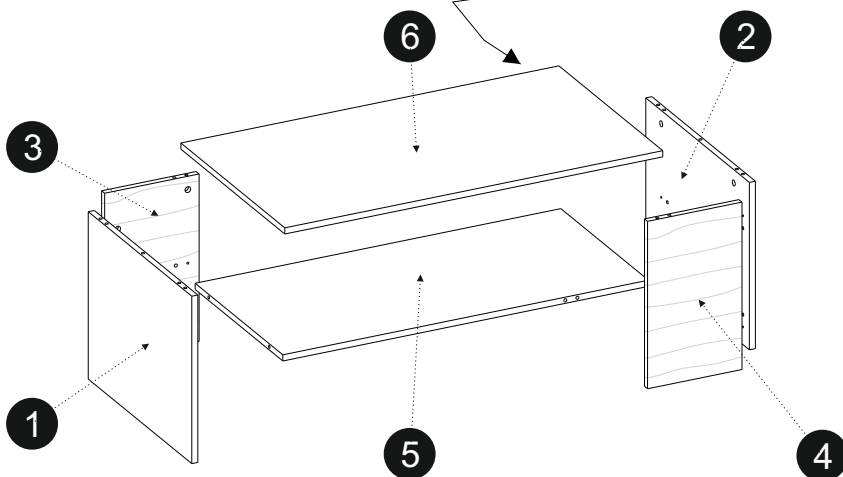

„MEBLE-OKMED” DEMKO - SPÓŁKA JAWNA
 ul. Kolejowa 13, 14-500 Braniewo, POLSKA
www.mebleokmed.pl (+48) 55 243 27 26
firma@mebleokmed.pl

SERIA: .../...

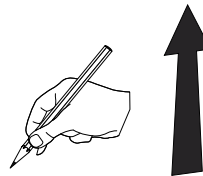
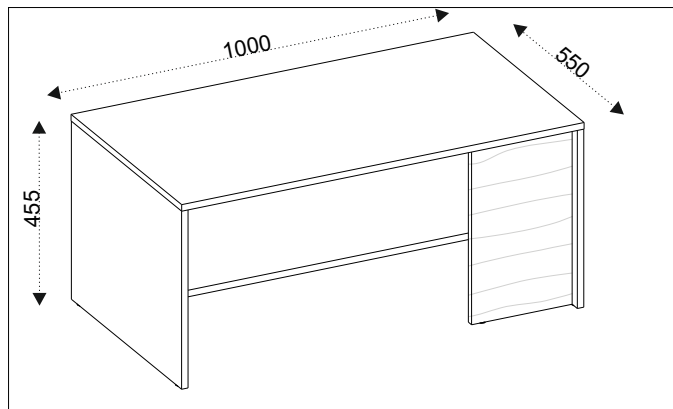
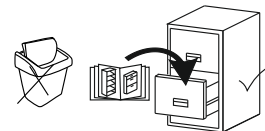

1/1				
	L	W	T	
1	548	434	16	x1
2	548	434	16	x1
3	434	250	16	x1
4	434	250	16	x1
5	967	464	16	x1
6	1000	550	16	x1

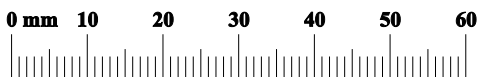

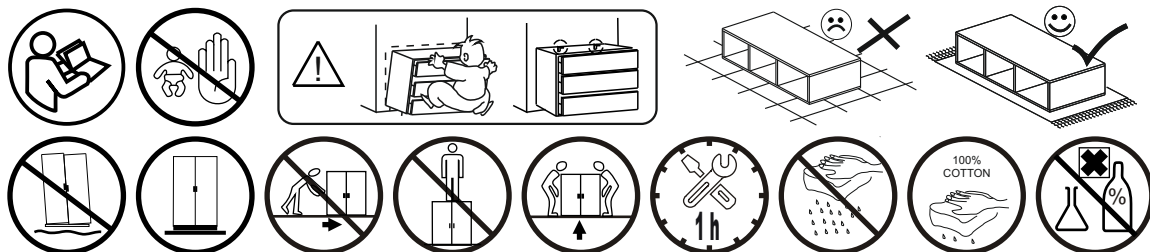
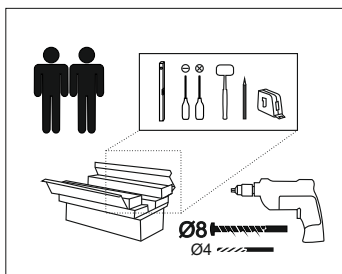

KK1	1	SG2	6	ZM1	16
				KD1	18
				ZM1B	16
				ZM1A	16

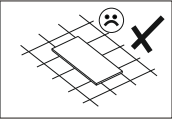
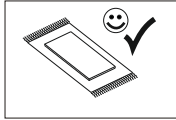

01

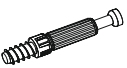

	8x35		ZM1B	16		ZM1A	16
KD1	18	ZM1B	16	ZM1A	16		

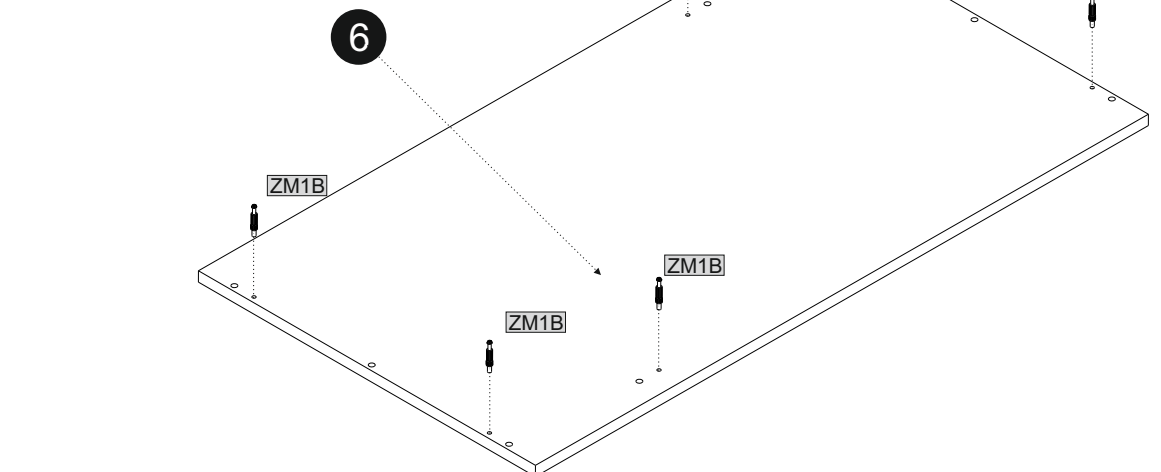
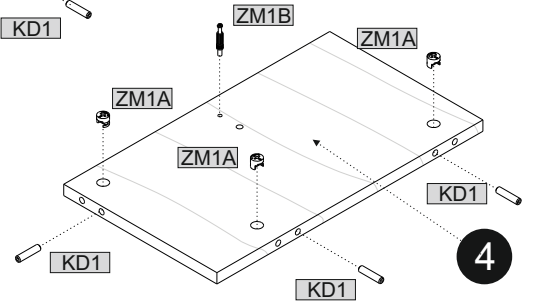
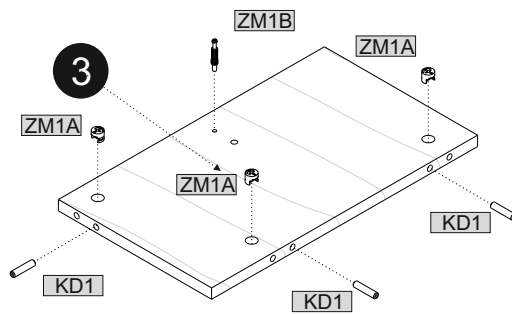
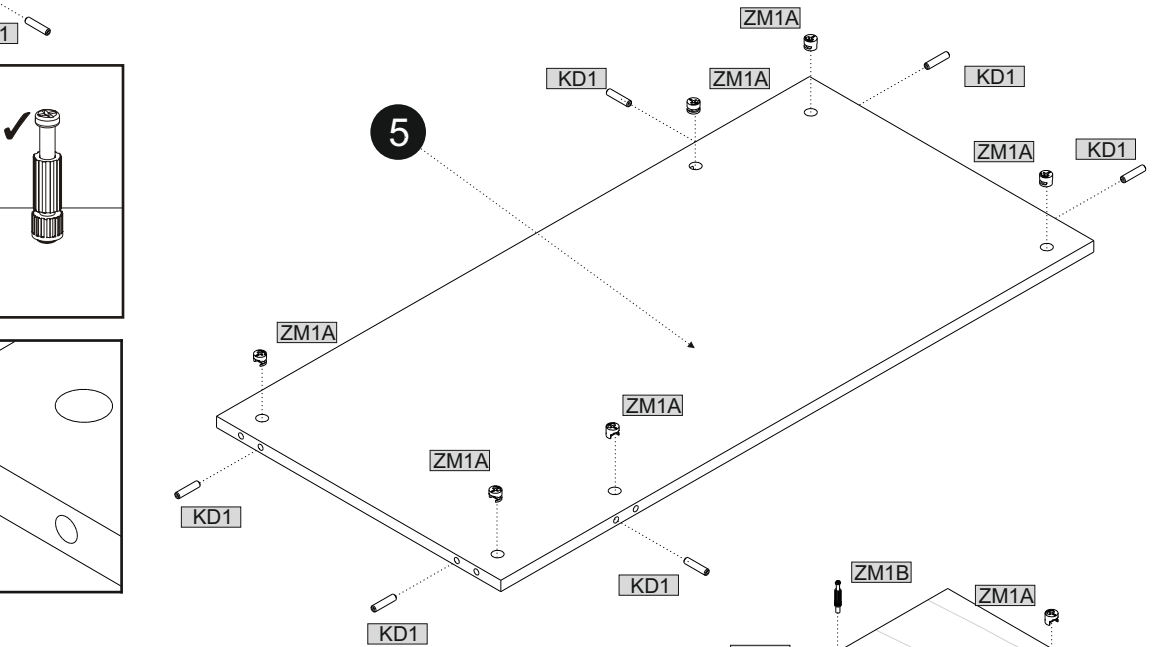
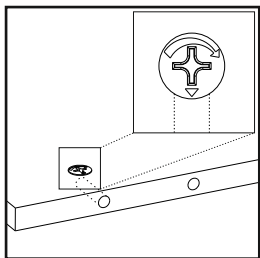
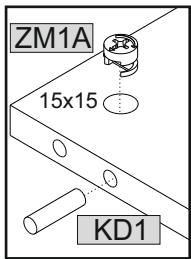
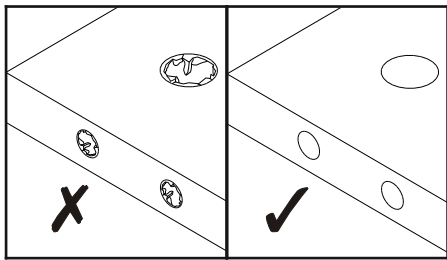
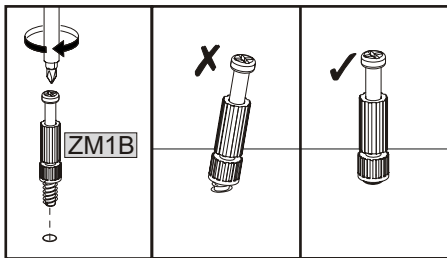
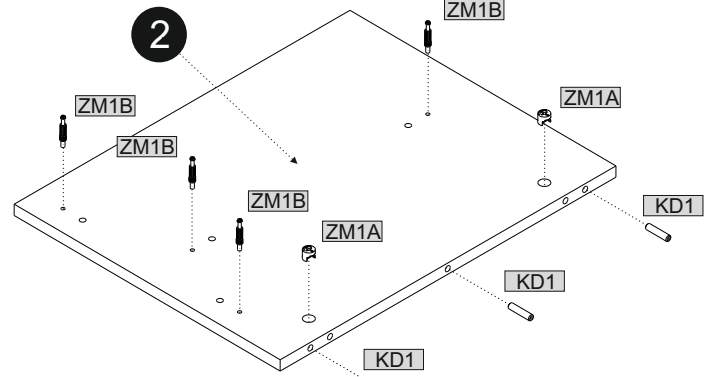
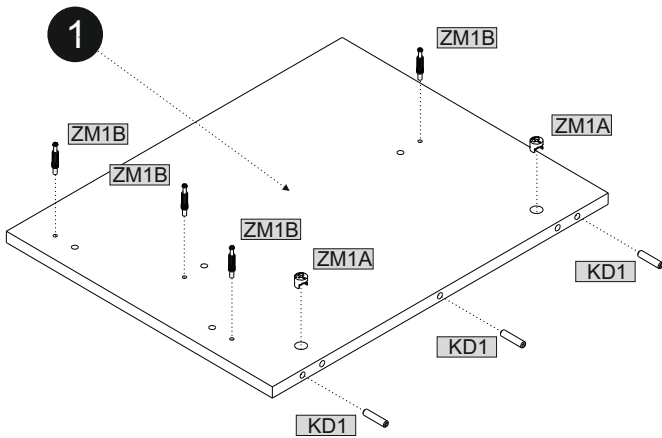

02

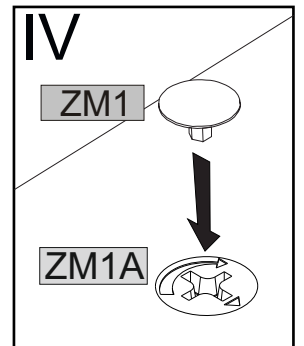
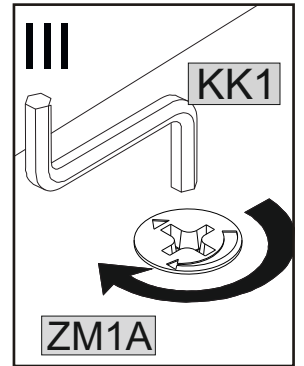
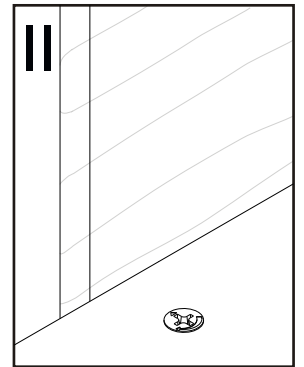
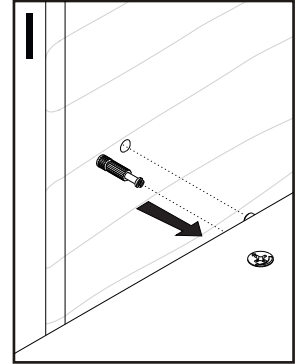
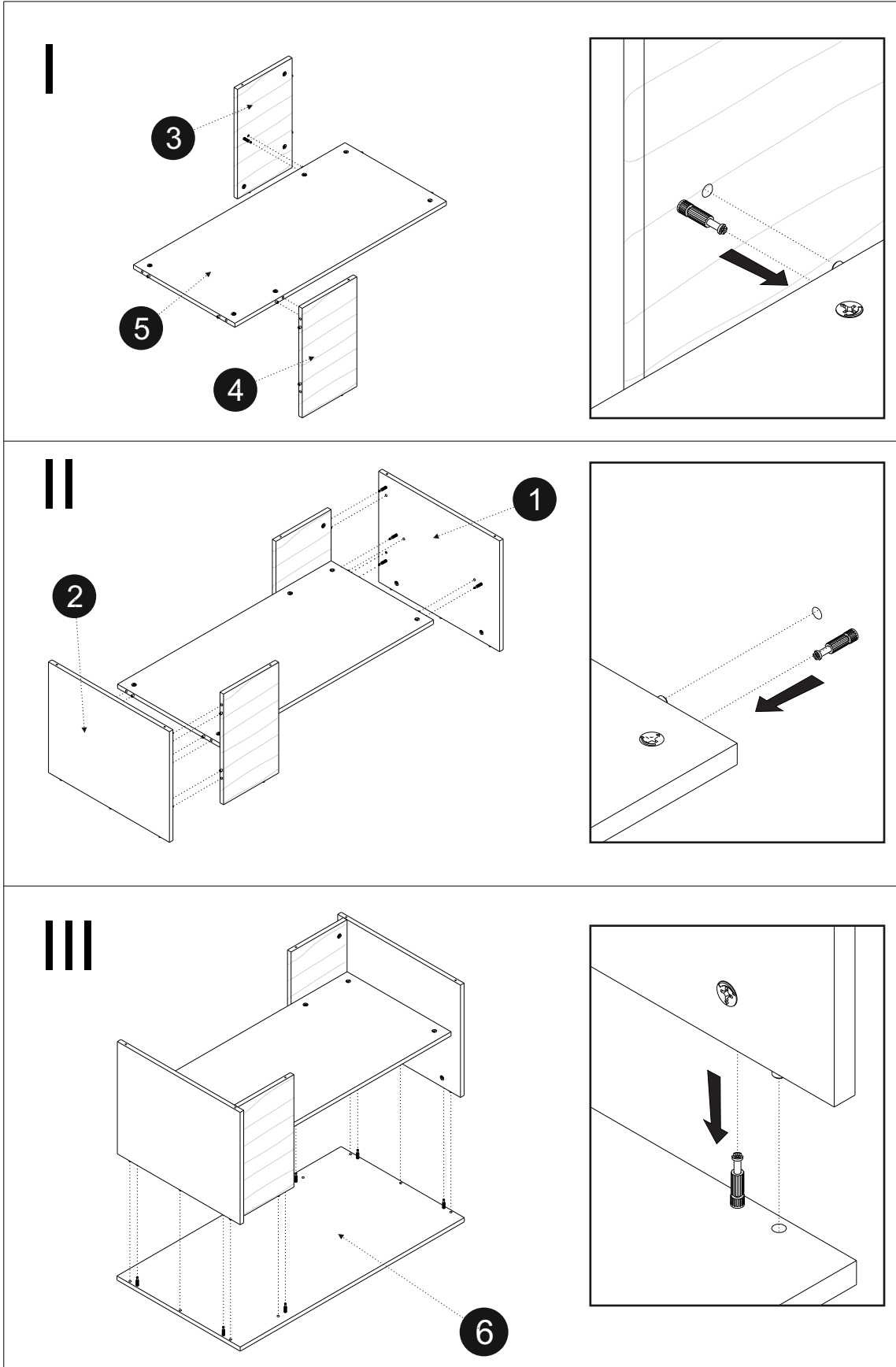
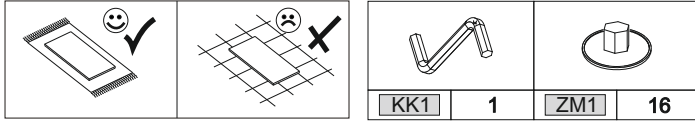

03

