

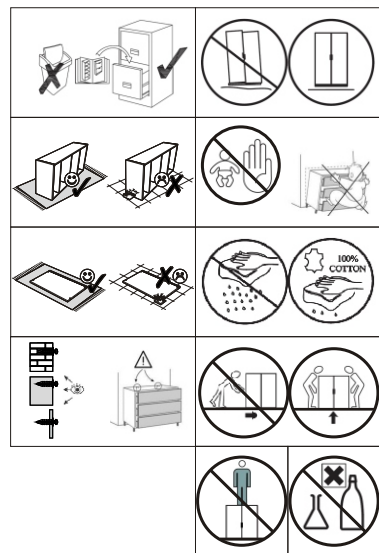

Producent: **MEBLE OKMED** POLAND
 POLSKA 14-500 Braniewo ul. Kolejowa 13
 www.mebleokmed.pl tel. (+48) 55 243-02-41

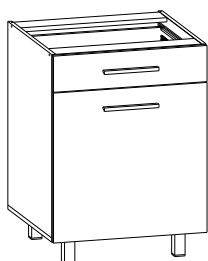

i	1/1	
	BG 16x717x320	X1

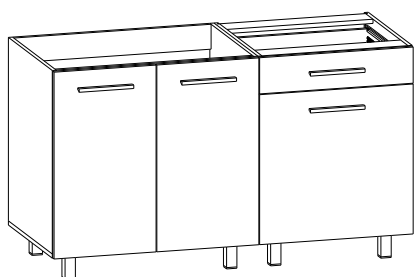
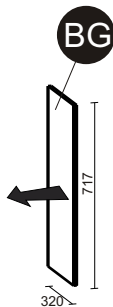
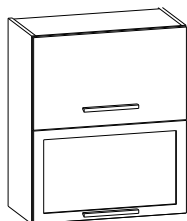
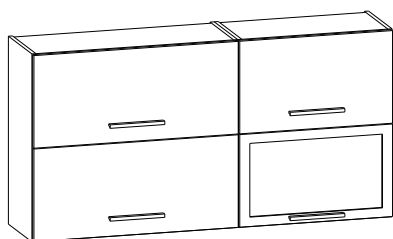
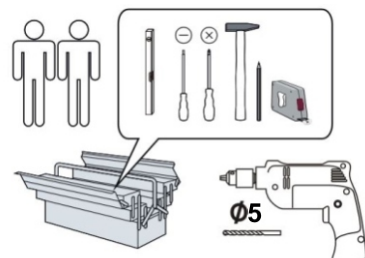