

TORONTO D 2D

MEBLE-OKMED
DEMKO

„MEBLE-OKMED” DEMKO - SPÓŁKA JAWNA
ul. Kolejowa 13, 14-500 Braniewo, POLSKA
www.mebleokmed.pl (+48) 55 243 27 26
firma@mebleokmed.pl

SERIA: .../...

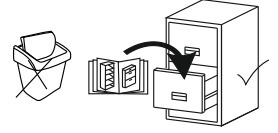

TORONTO
Szafa 2D
Front: DĄB, WARMIA
Korpus: CZARNY / DĄB WARMIA
MEBLE OKMED Demko SP J.
14-500 Braniewo, Ul. Kolejowa 13

.../...

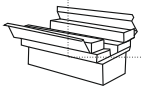
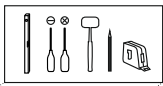
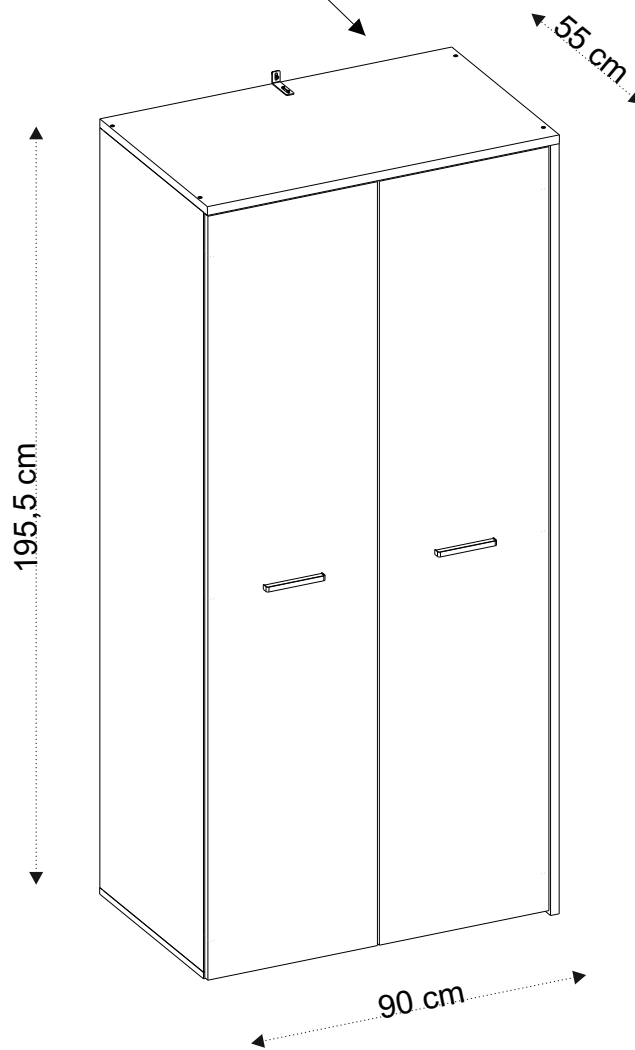

Ø8

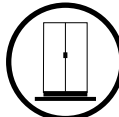
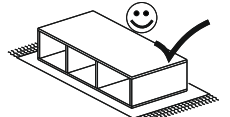
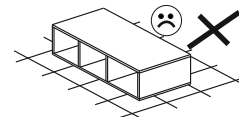
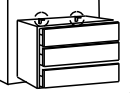
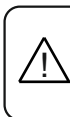



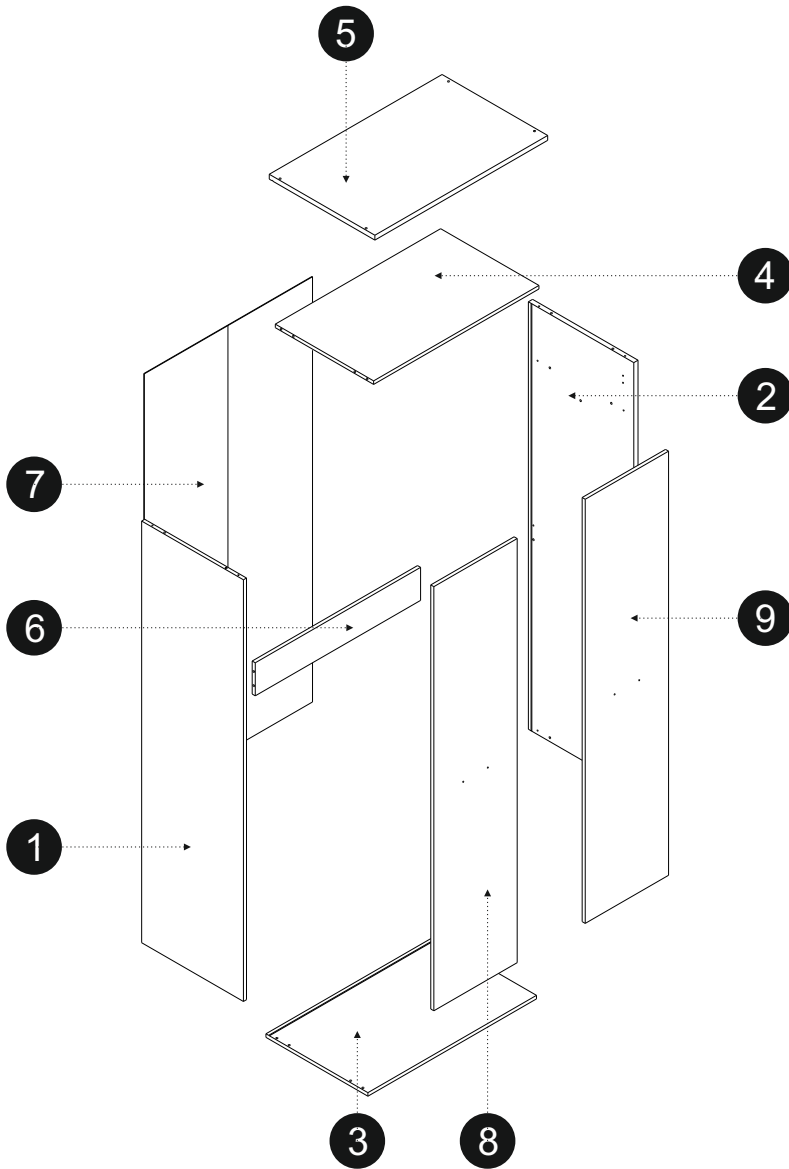







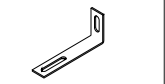
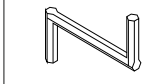



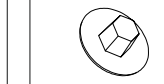

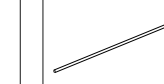
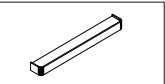
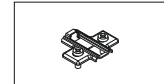
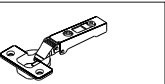
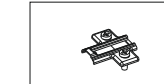
TORONTO D 2D

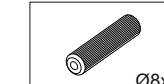

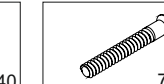
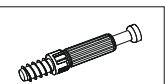
 1/3				
	[mm]	[mm]	[mm]	
3	878	531	16	x1
4	861	512	16	x1
5	900	550	22	x1
6	861	150	16	x1

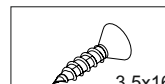
2/3				
	[mm]	[mm]	[mm]	
1	1902	530	16	x1
2	1928	549	22	x1

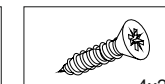
3/3				
	[mm]	[mm]	[mm]	
7	1918	876	3	x1
8	1913	434	16	x1
9	1913	434	16	x1

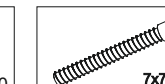
							
KS1	KK1	S1	SS3	SG2	ZM1	UD1	DS1
1	1	12	3	2	4	2	1
							
U61	ZPH1	ZPH	ZWH1	ZWH	KT1	KRW1	K1
2	3	3	3	3	14	1	2
							
ZM1B	ZM1A	W11	W4	W6	WU	K2	
8	8	4	12	3	4	4	

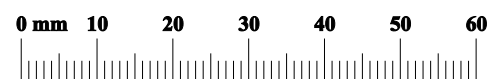



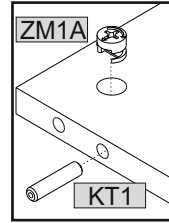
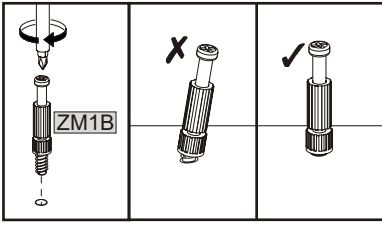
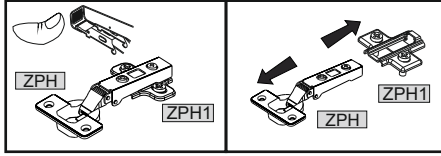
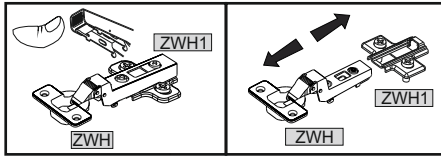
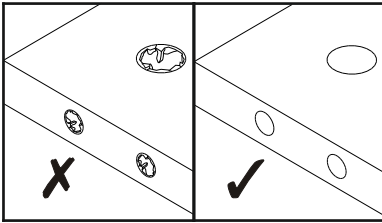

01

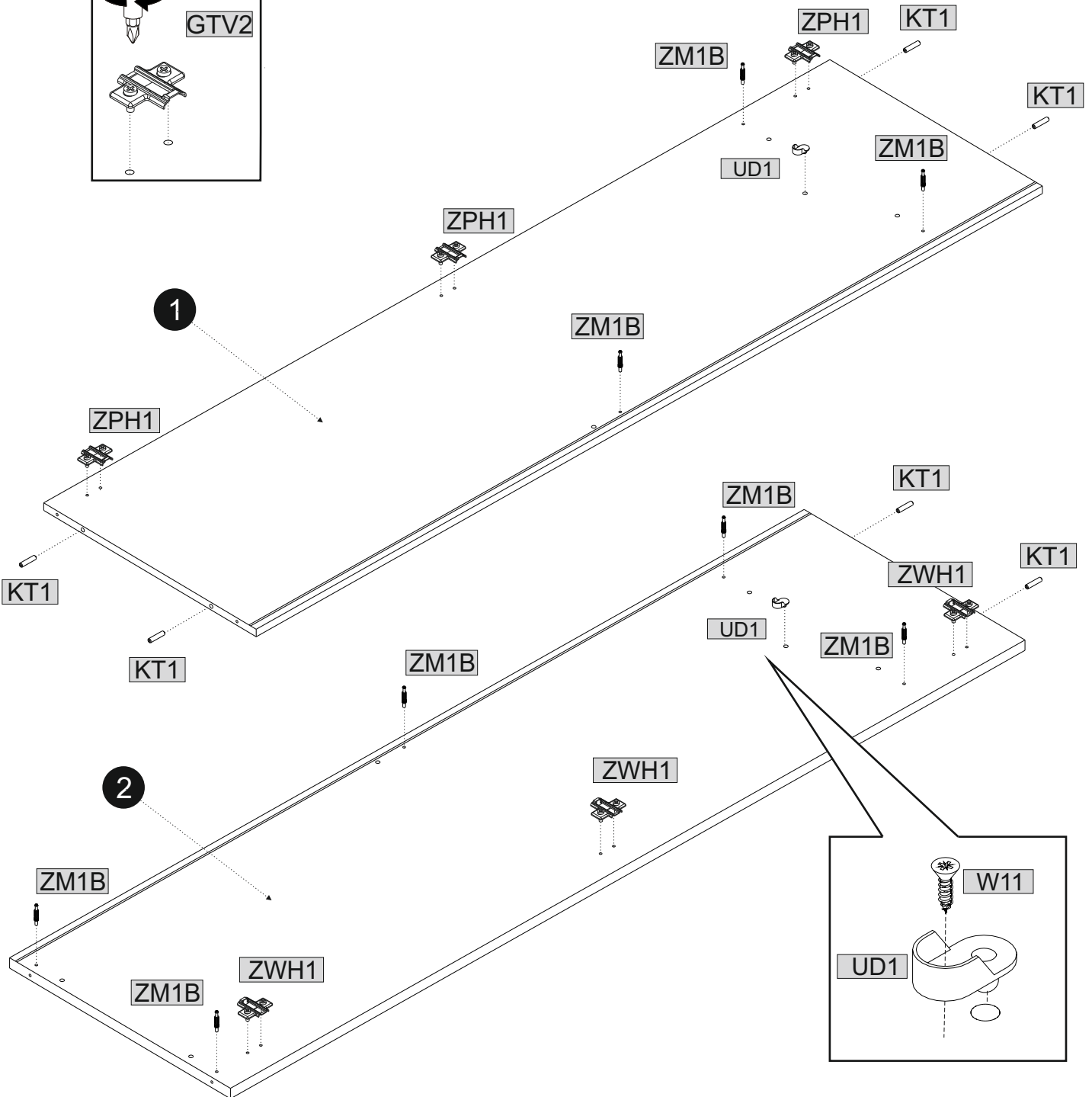
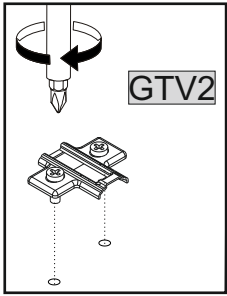

UD1	Ø8x35 KT1	3,5x16 W11
2	6	2
ZWH1	ZM1B	ZPH1
3	8	3
ZPH1	ZPH1	ZPH1
3	3	3



			4x20		15x12		Ø8x35
SS3	3	W6	3	ZM1A	8	KT1	8

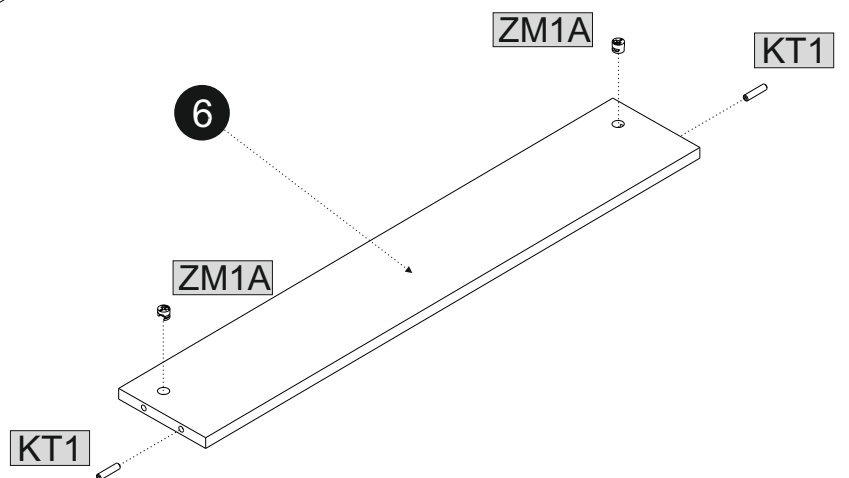
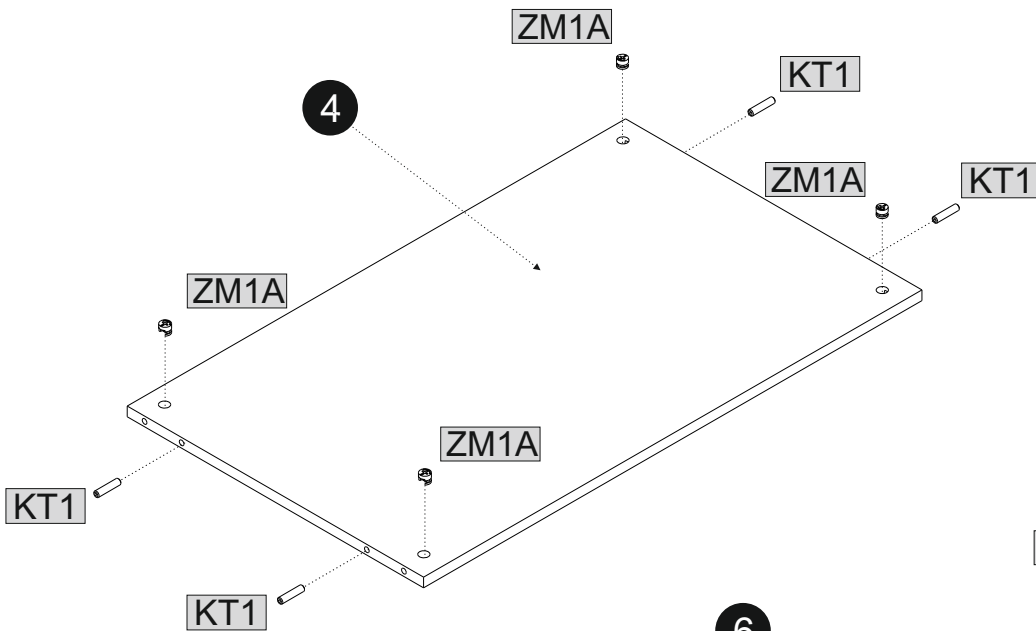
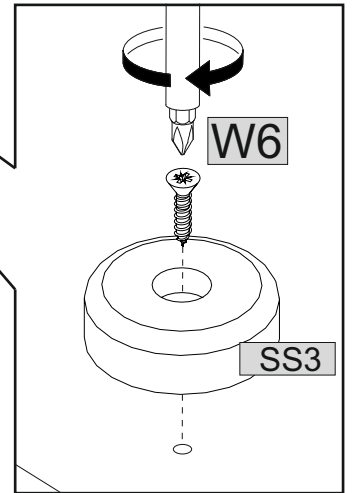
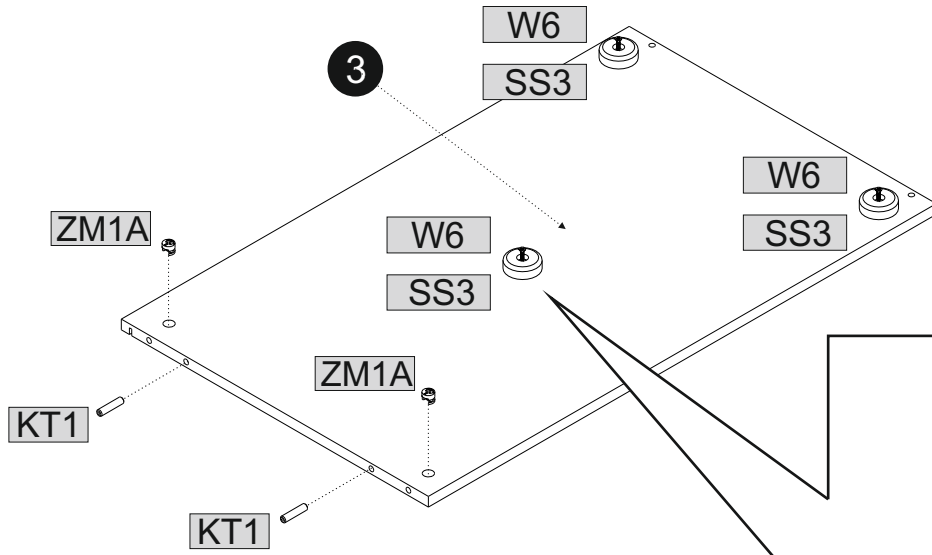

03

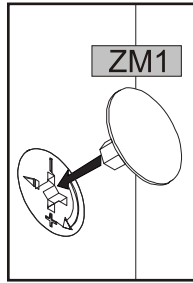
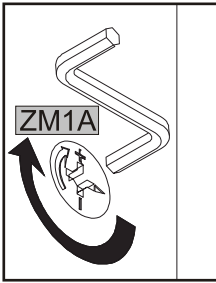

KK1	ZM1
1	4

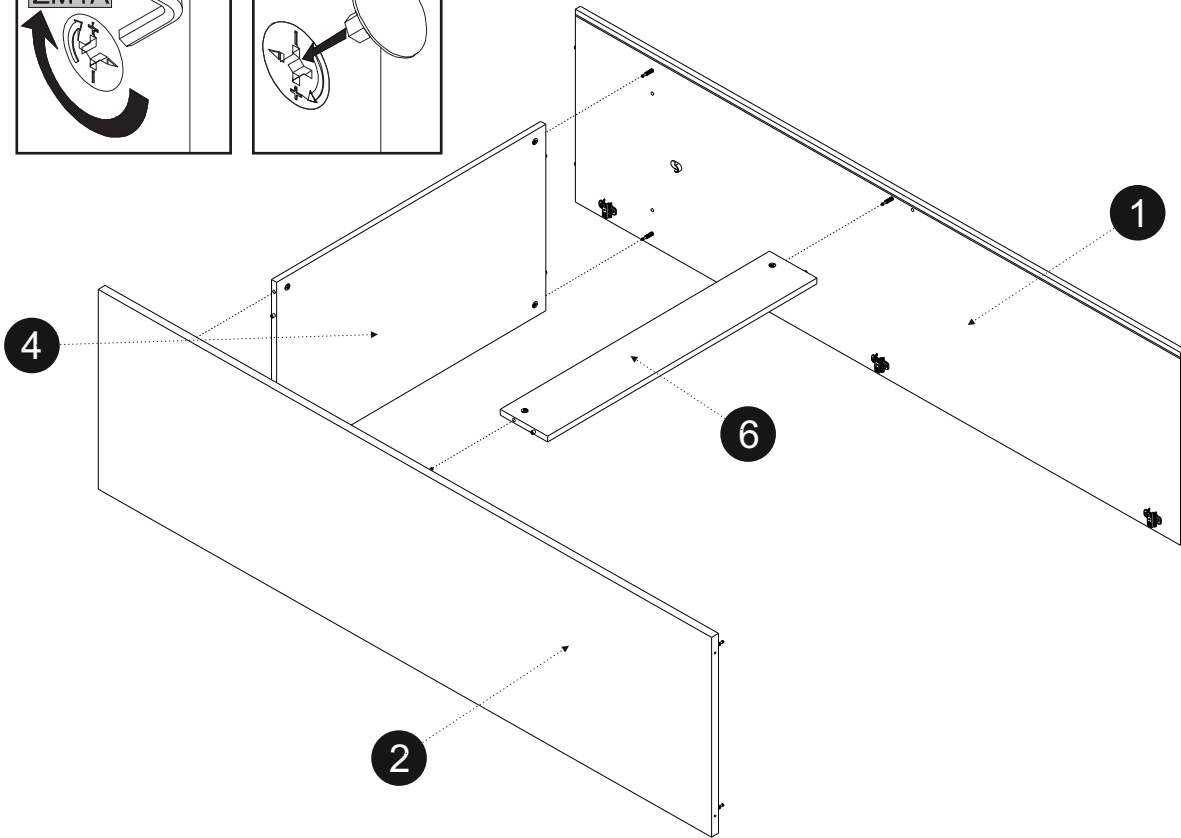

04

KK1	K2
1	4

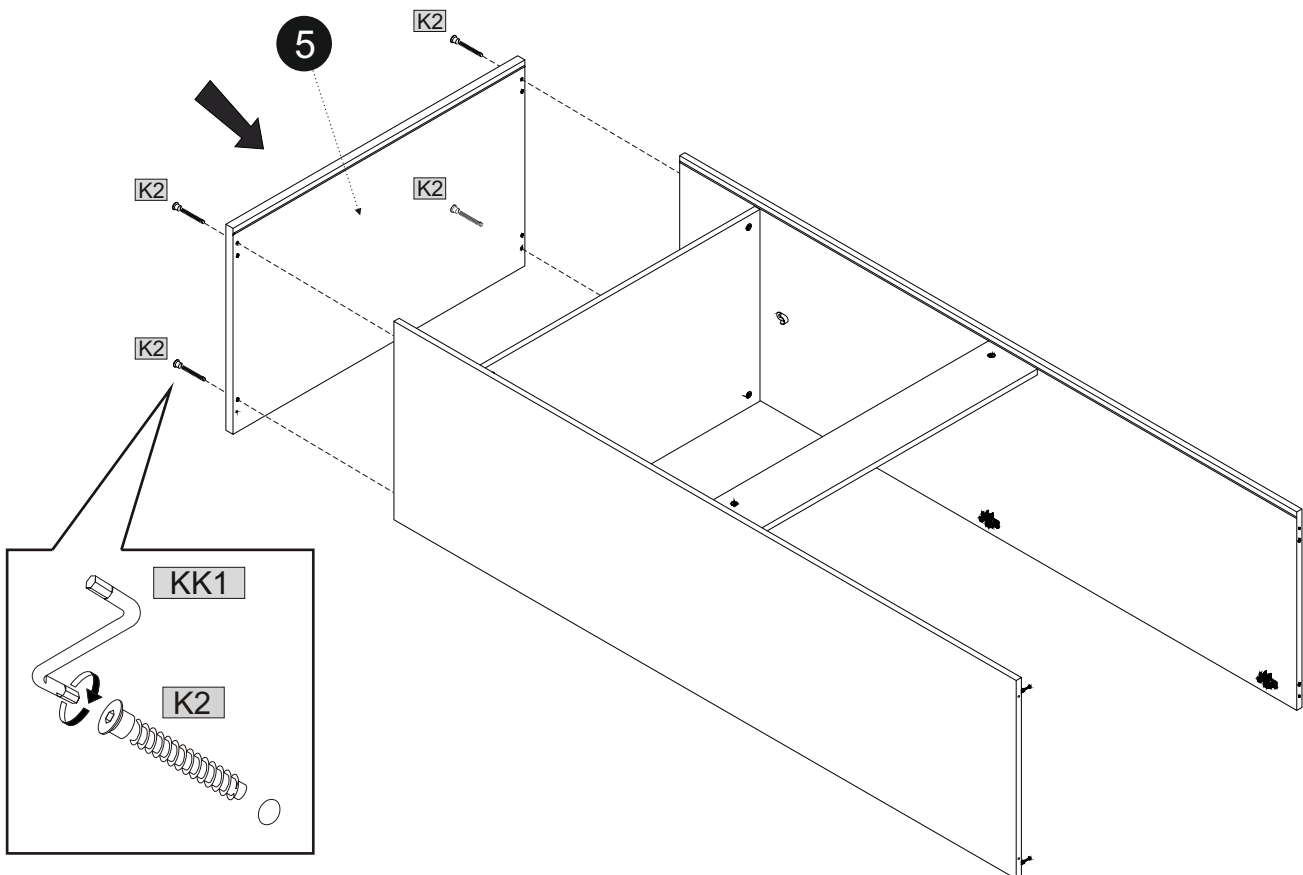

05

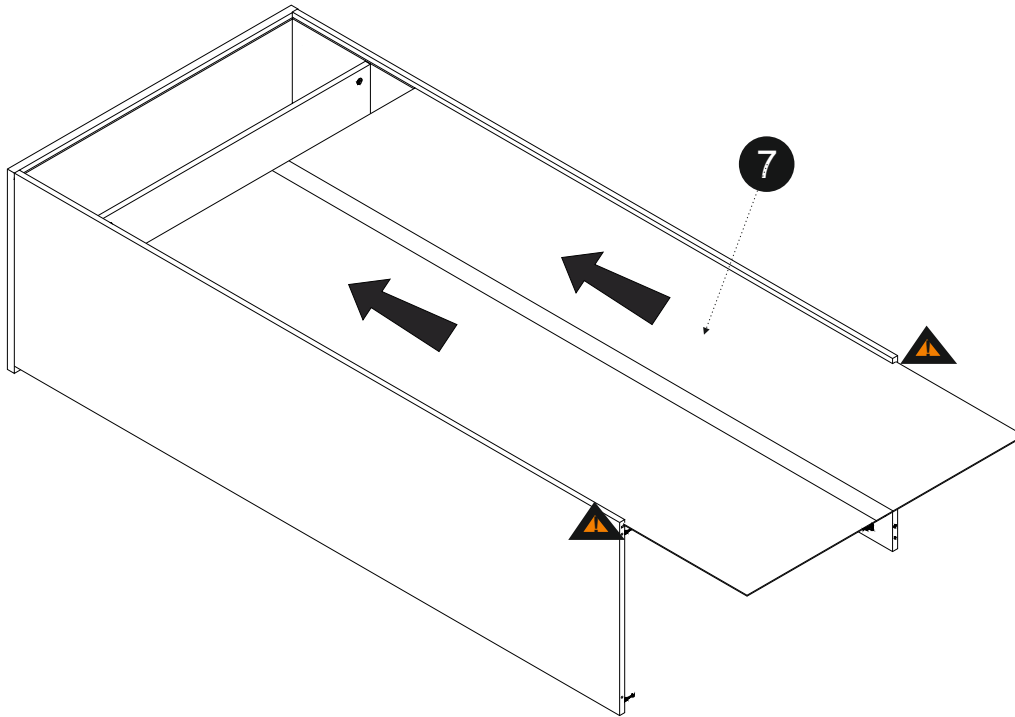
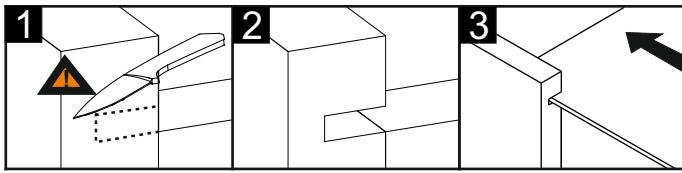

06

KK1	7x50
1	K1
	2

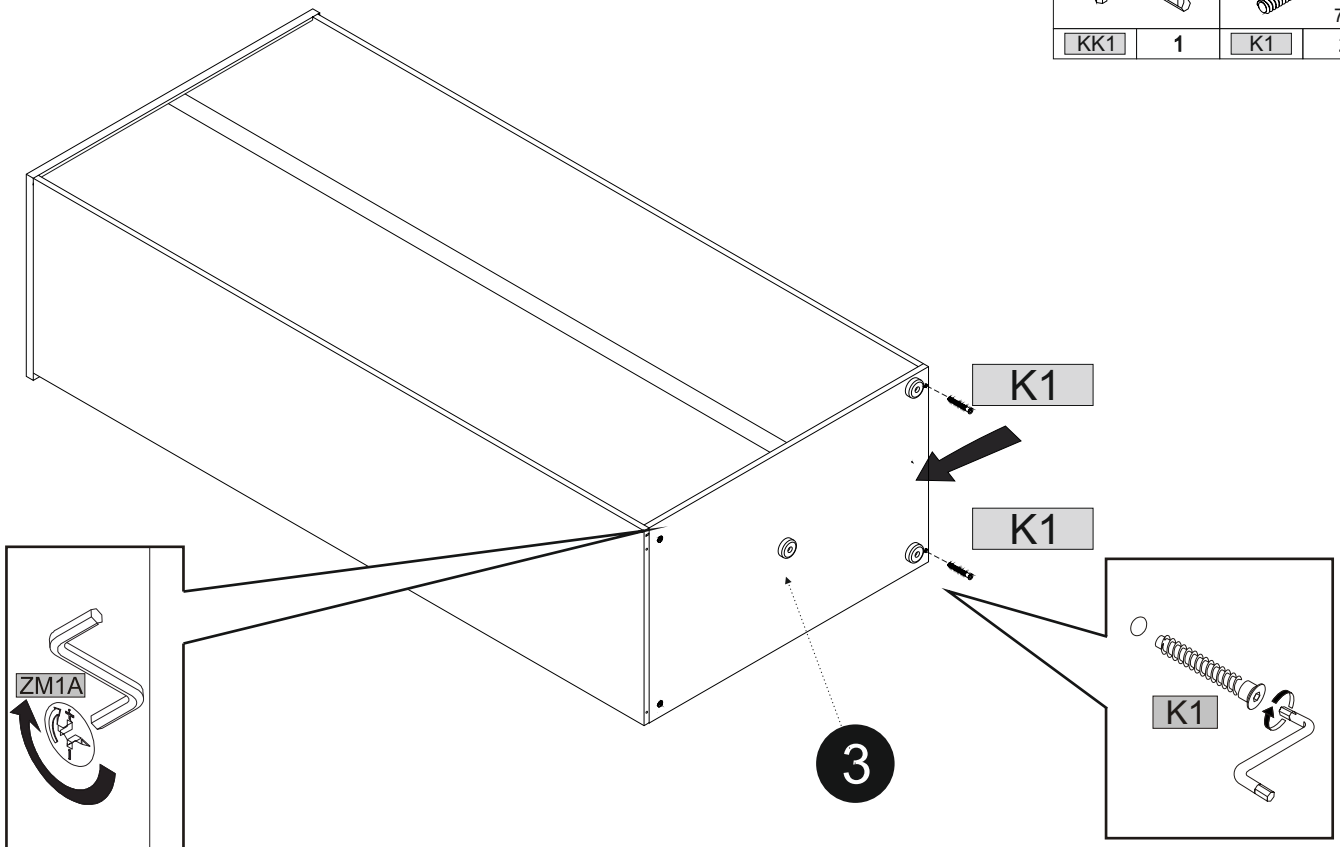

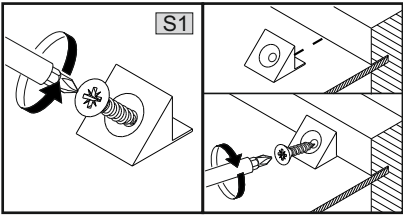

07

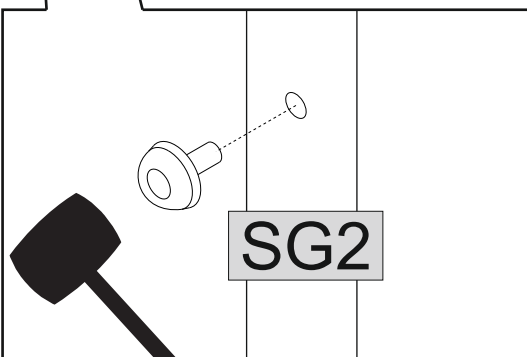
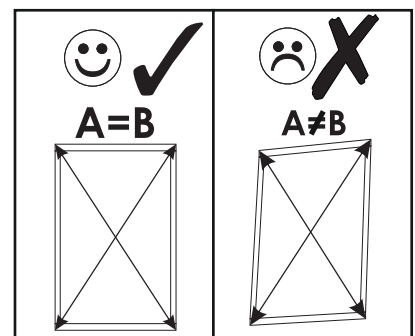
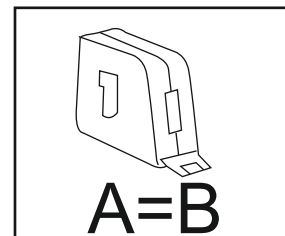
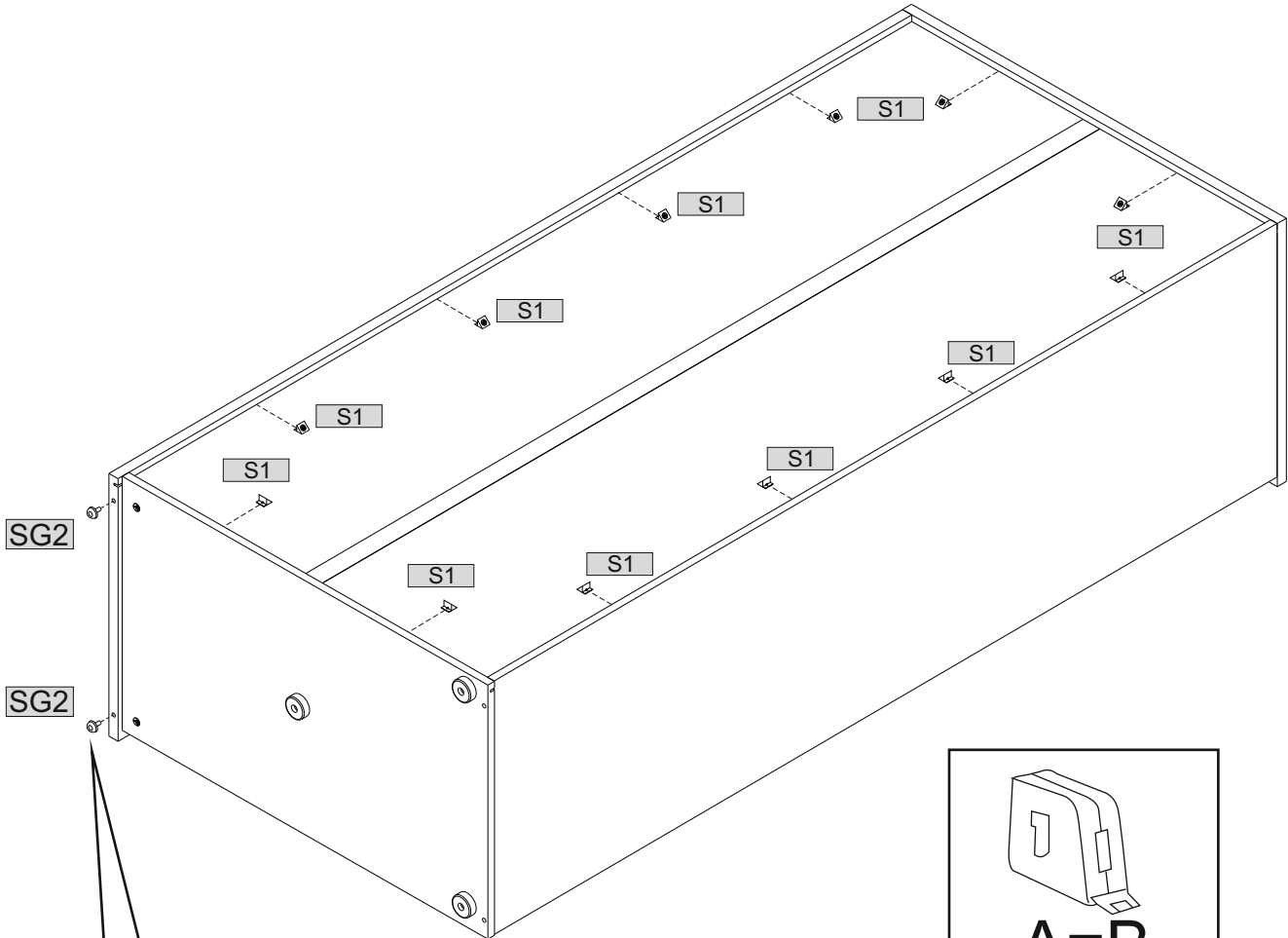

SG2	2
S1	12



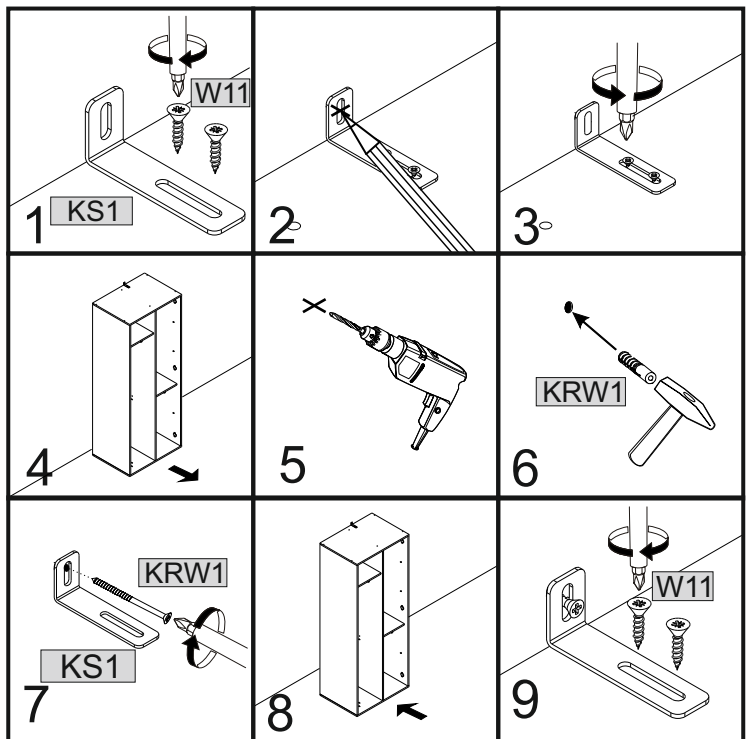
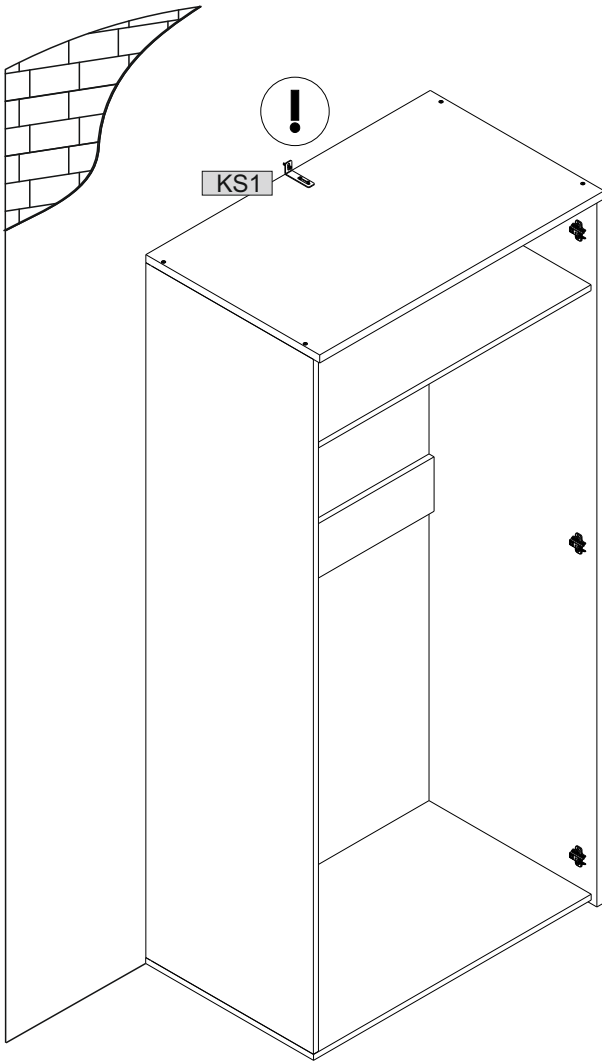

			3,5x16		08x40
KS1	1	W11	2	KRW1	1

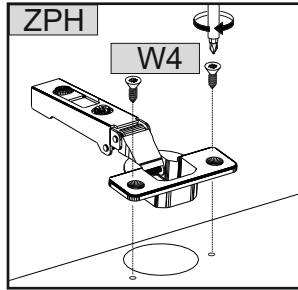
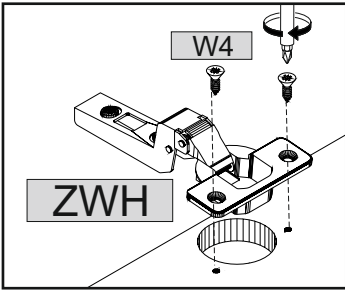

09

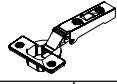
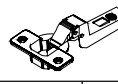

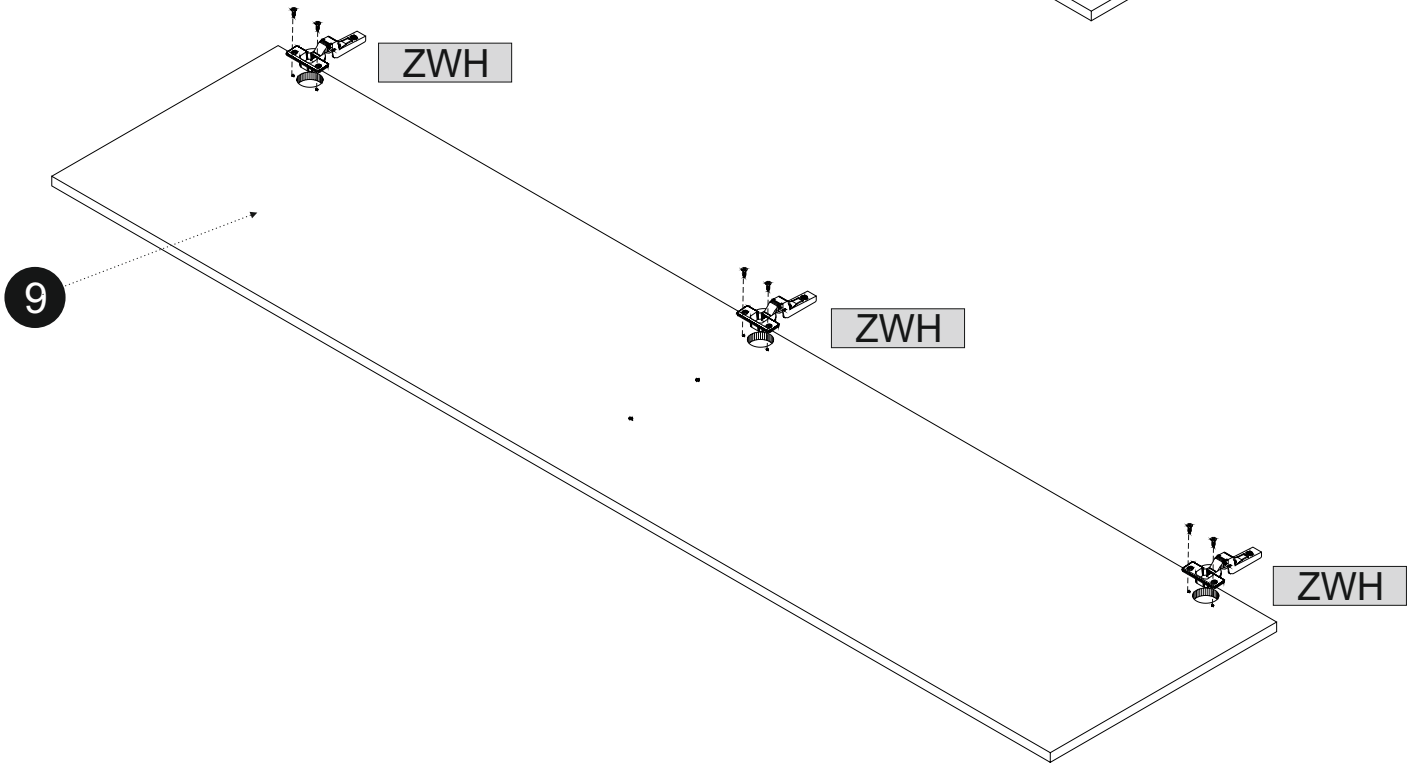
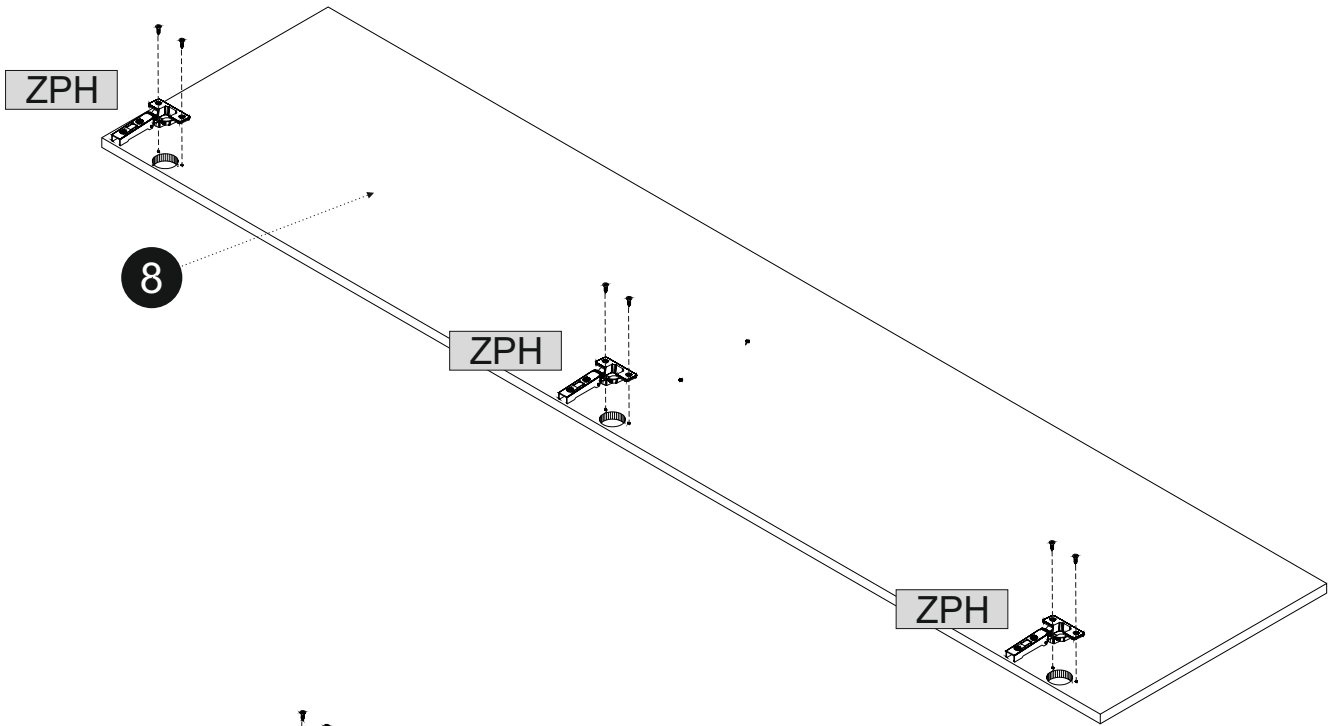

					4x13
ZPH	3	ZWH	3	W4	12

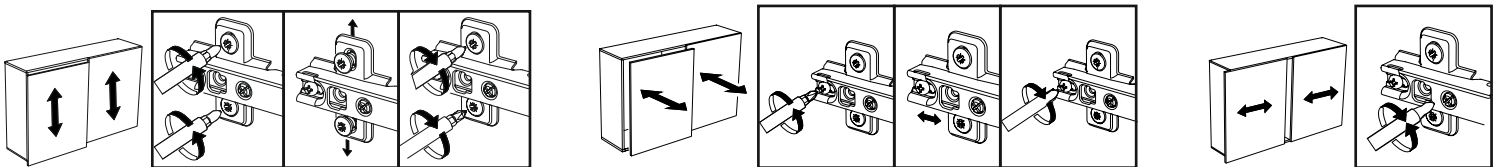
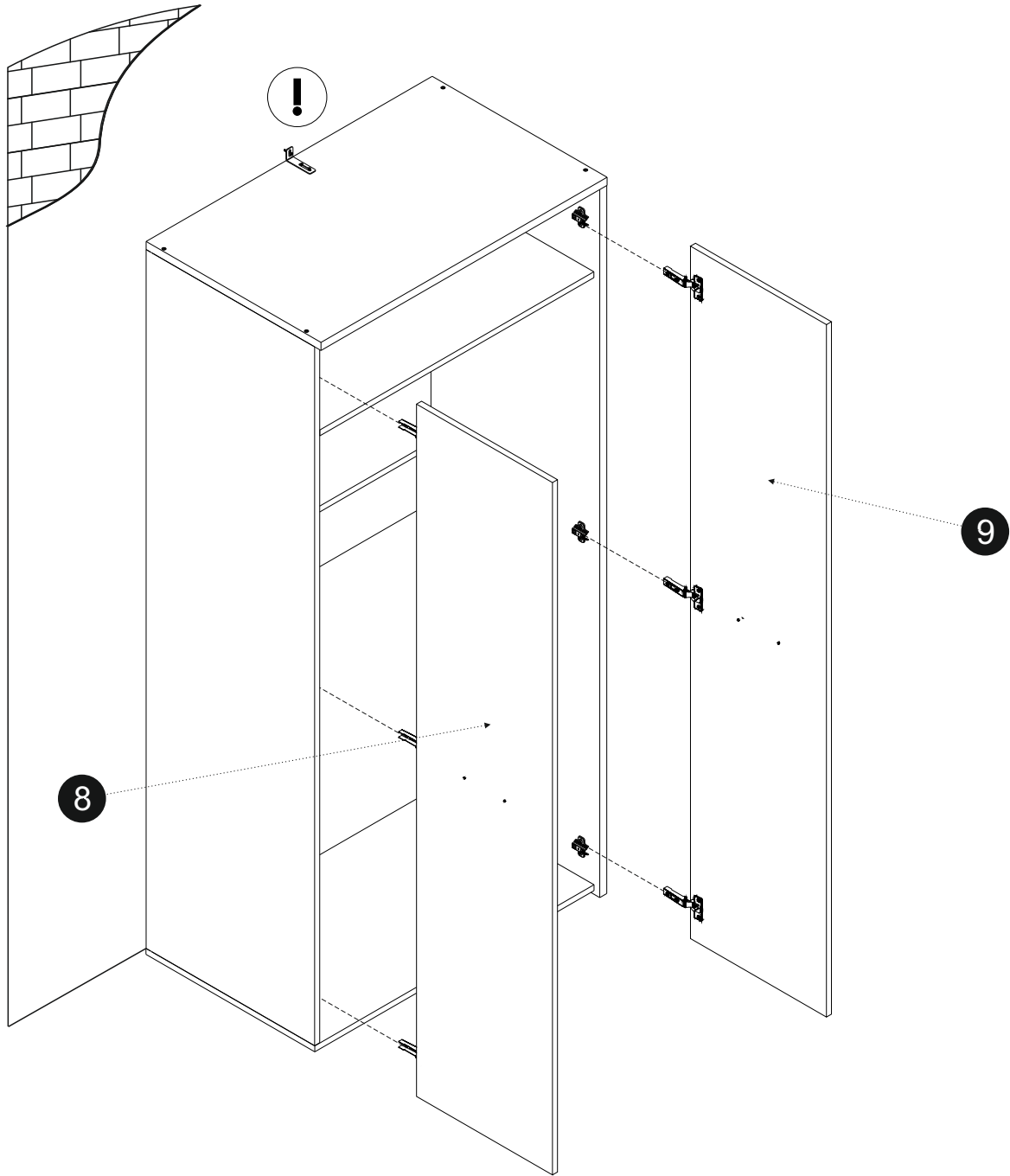
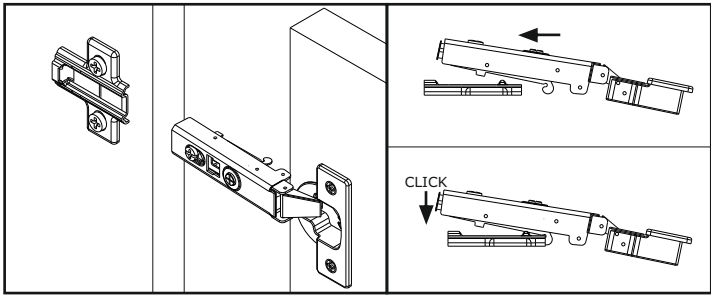

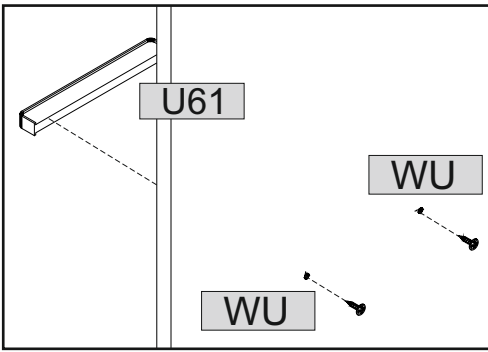



					
U61	2	WU	4x30 4	DS1	1

