

1/1	1	16x300x717	x1
	2	16x300x717	x1
	3	16x282x567	x1
	4	16x282x567	x1
	5	16x262x567	x1
	6 a,b	16x561x338	x2
	7	3x585x355	x1
	8	3x585x355	x1

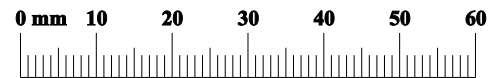

<p>PL1</p> <p>x5</p>	<p>ZP1</p> <p>x2</p>	<p>ZP</p> <p>x2</p>	<p>AM1</p> <p>x2</p>	
<p>K1</p> <p>ø7x50</p> <p>x12</p>	<p>ZWP1</p> <p>x2</p>	<p>ZWP</p> <p>x2</p>	<p>KK1</p> <p>x1</p>	<p>ZK</p> <p>ø11</p> <p>x12</p>
<p>KRW1</p> <p>ø8</p> <p>x4</p>	<p>ZRS1</p> <p>x2</p>	<p>U50</p> <p>x2</p>	<p>AM1</p> <p>x2</p>	<p>AM2</p> <p>x2</p>
<p>W7</p> <p>ø4x30</p> <p>x4</p>	<p>LMM1</p> <p>x2</p>	<p>WK1</p> <p>x1</p>	<p>W11</p> <p>ø3,5x16</p> <p>x8</p>	<p>W1</p> <p>ø3x16</p> <p>x15</p>

01

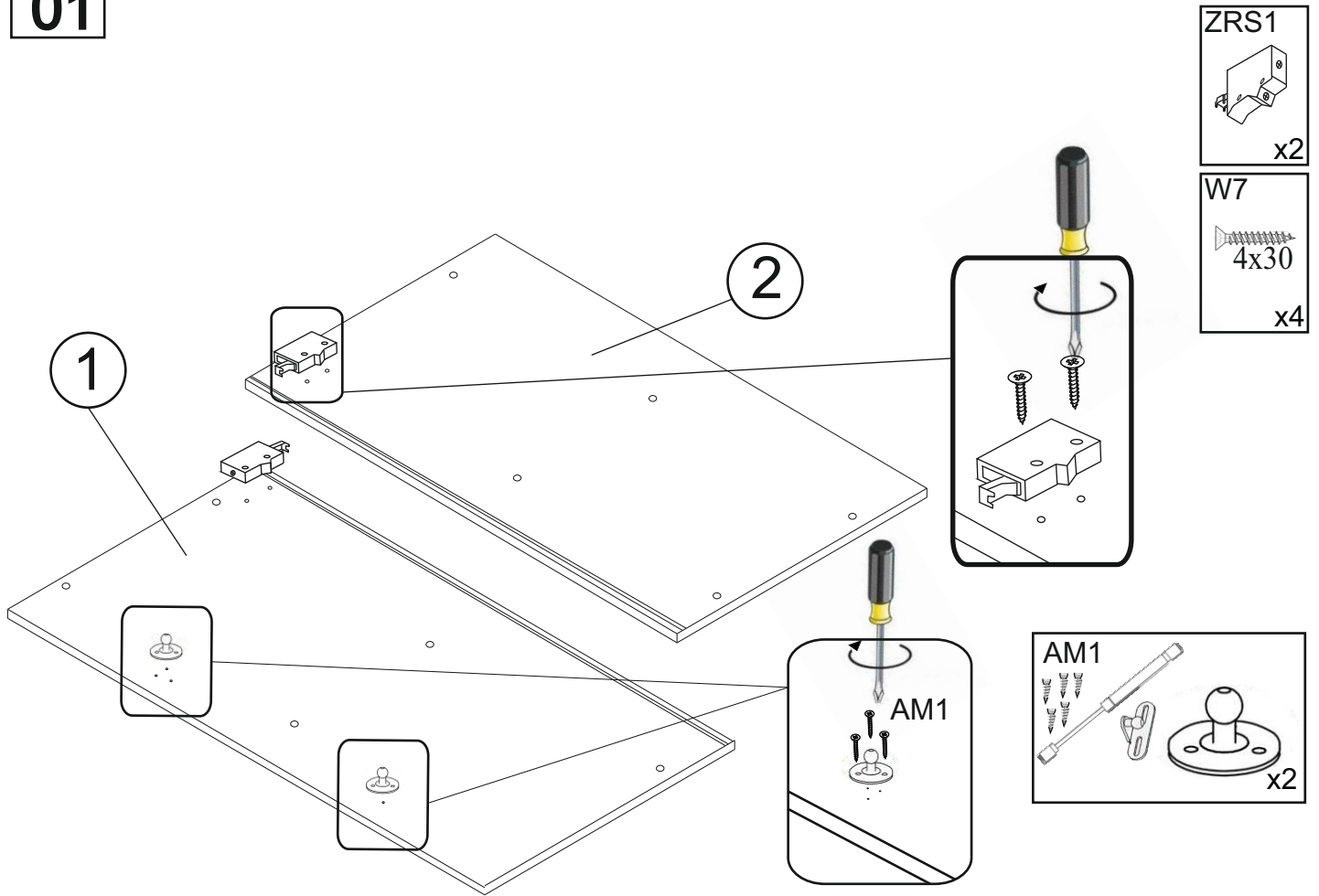

02

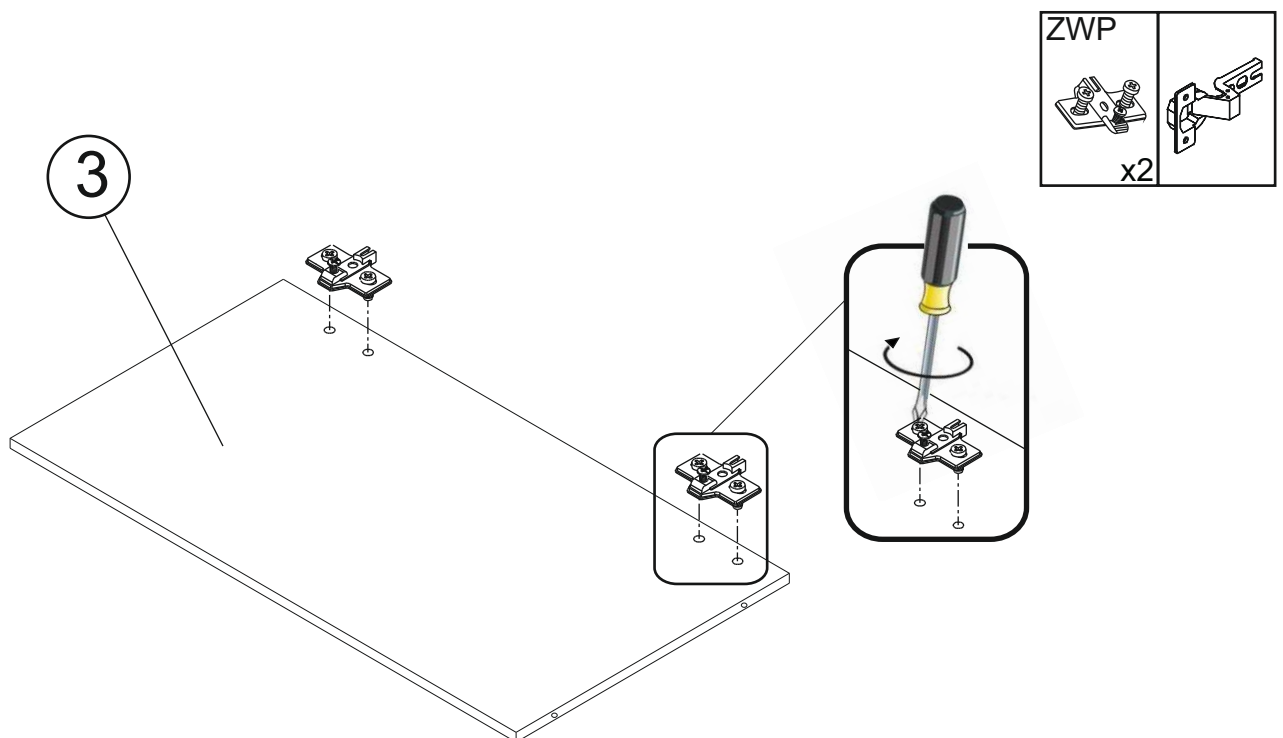

03

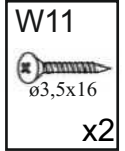
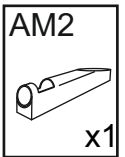
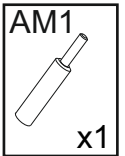
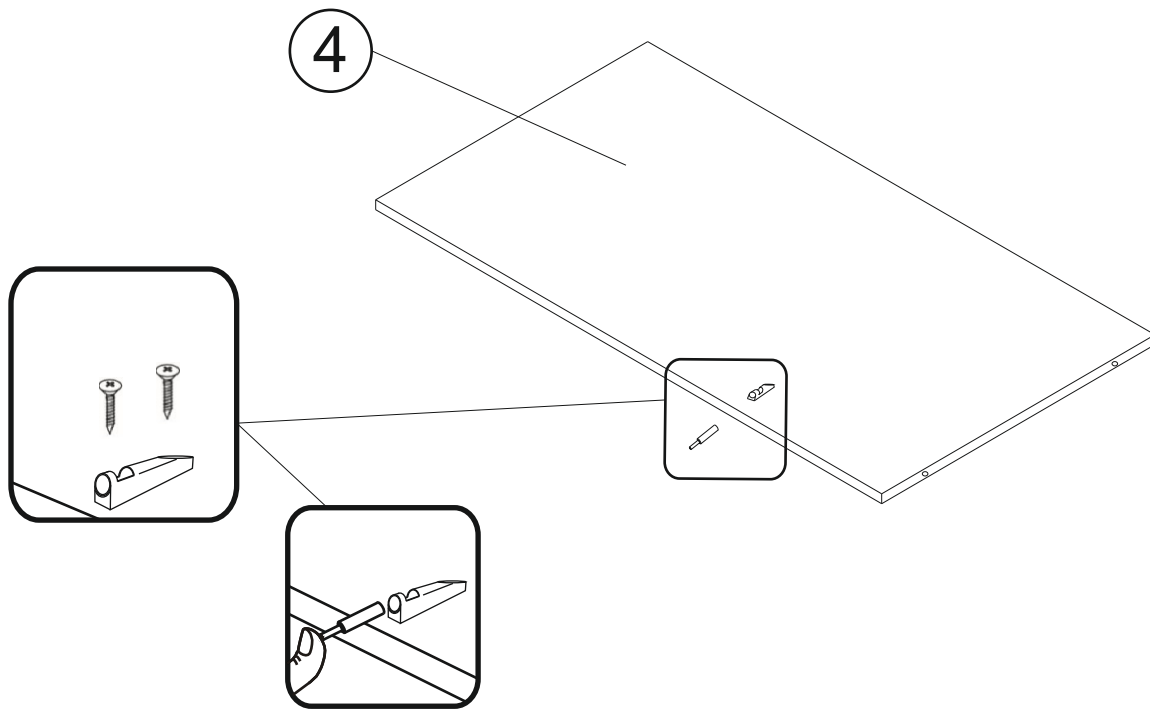

04

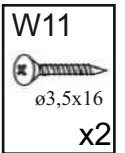
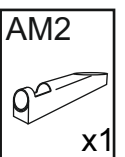
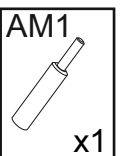
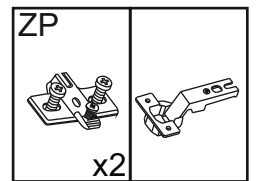
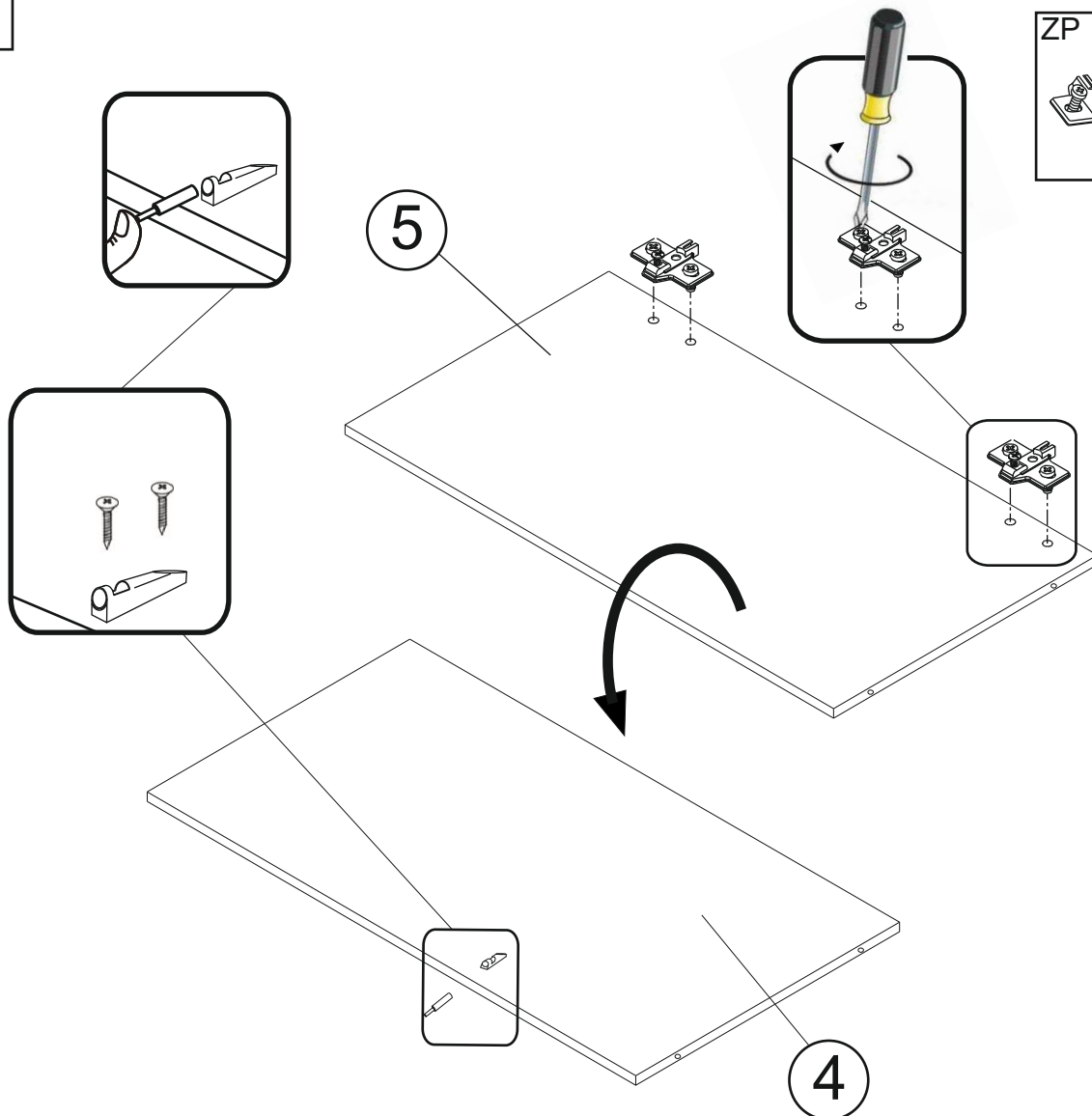

05

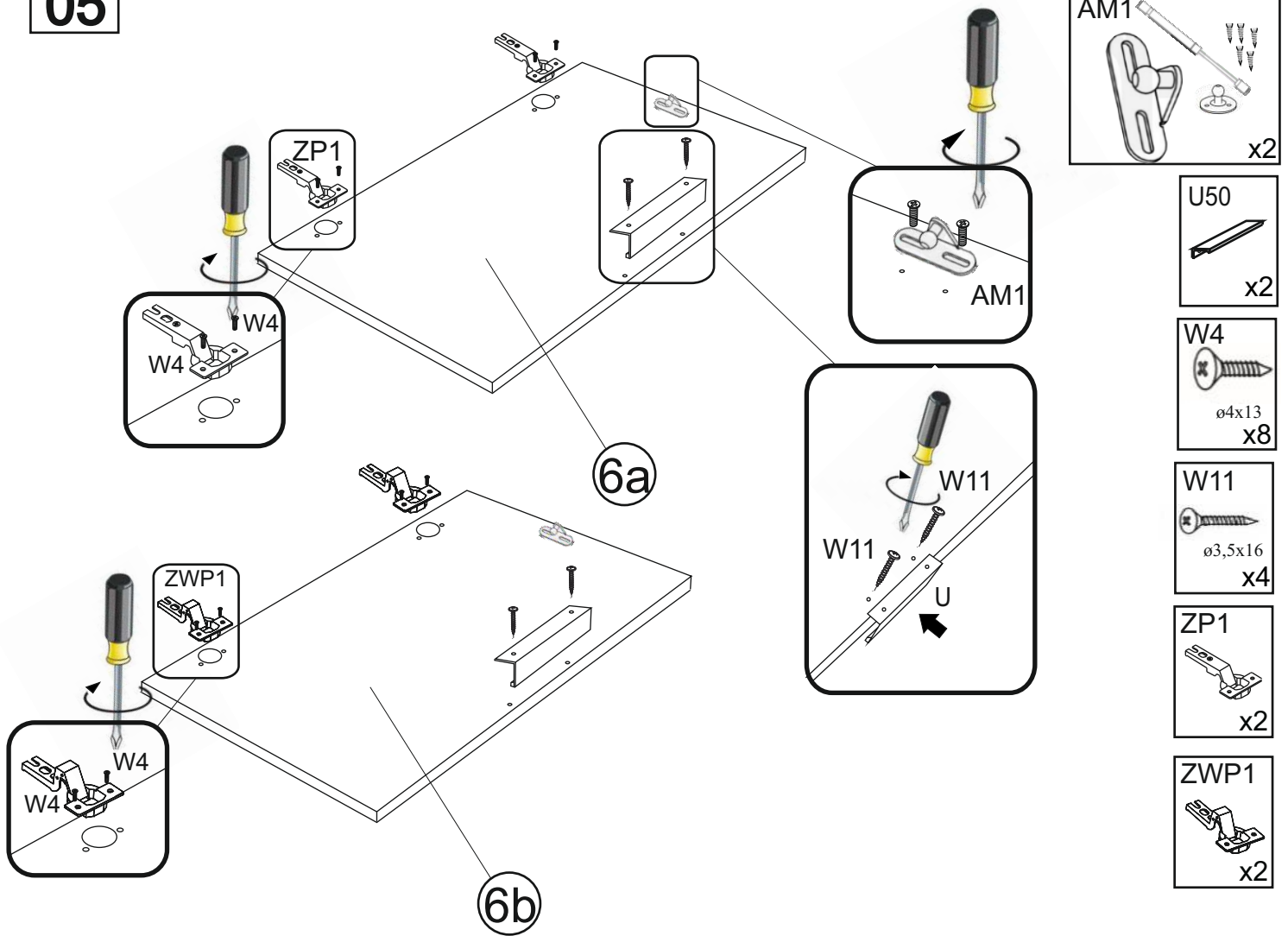

06

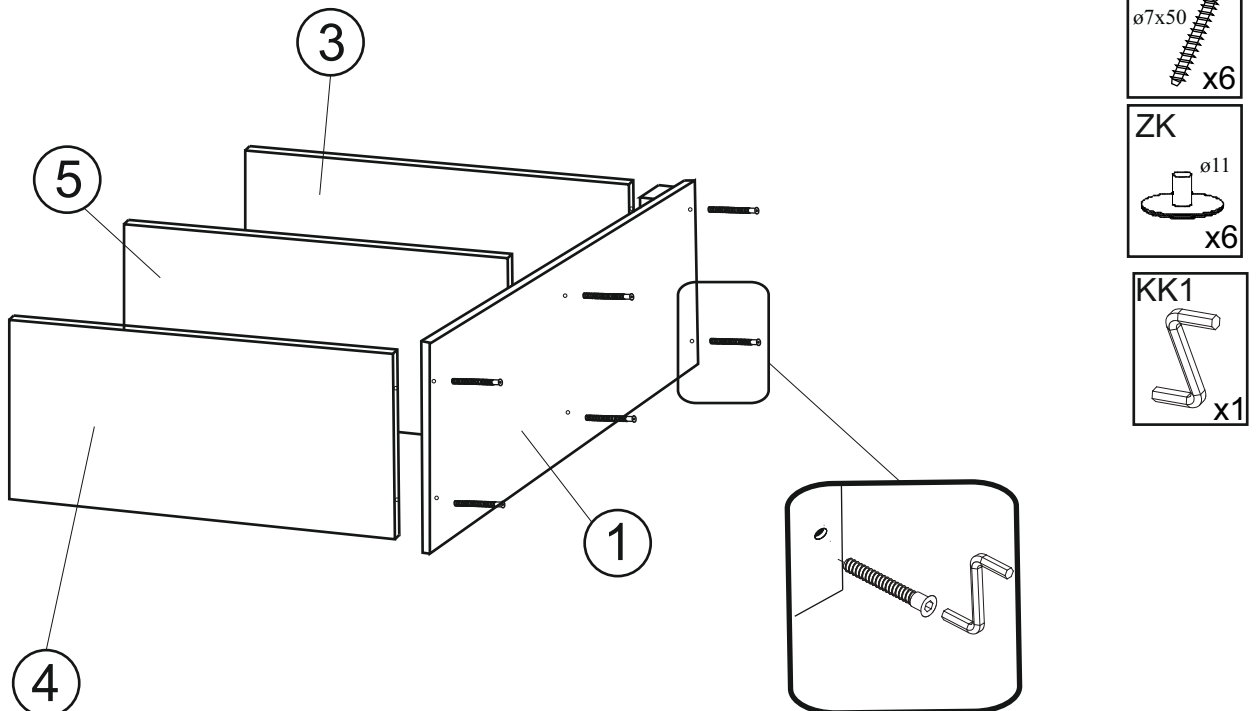

07

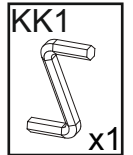
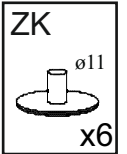
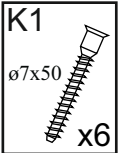
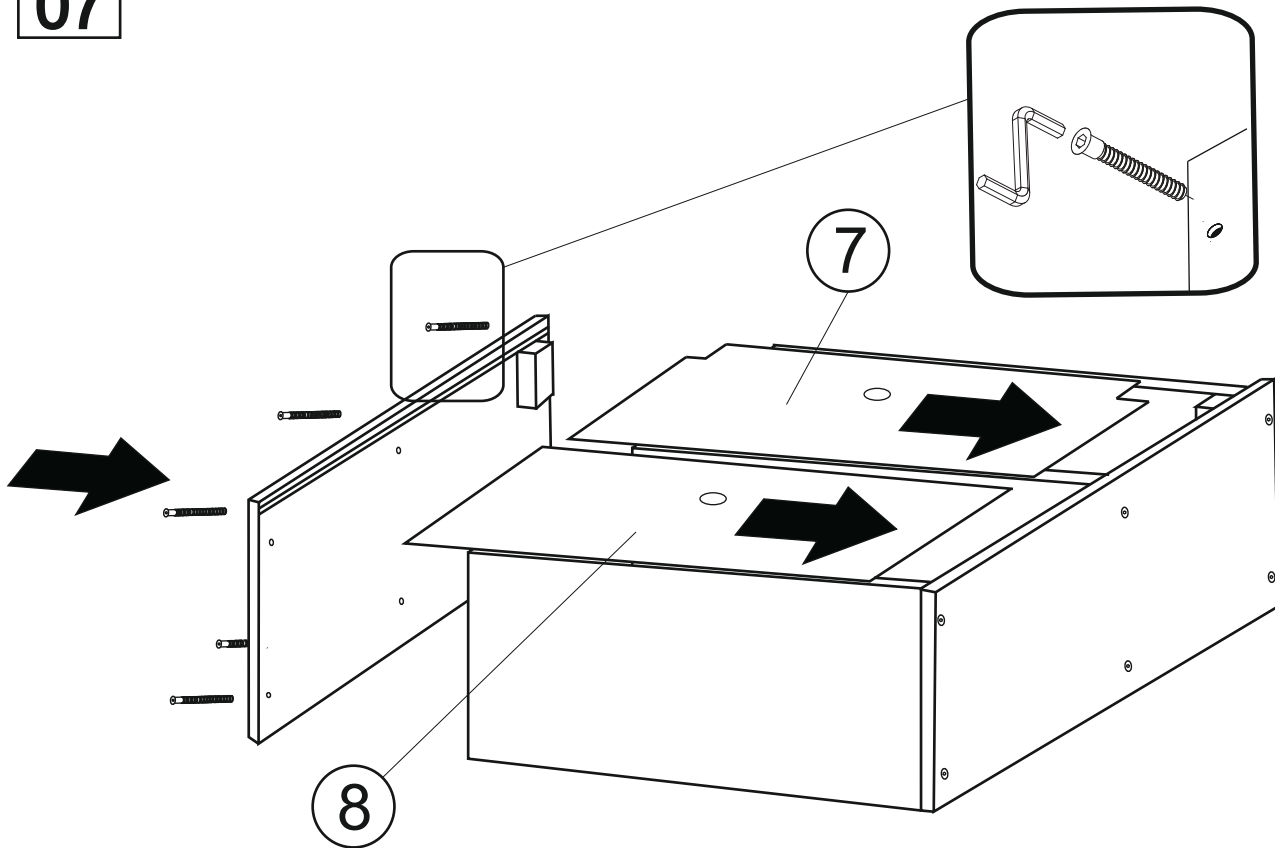

08

A=B

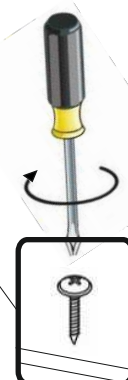
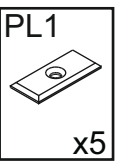
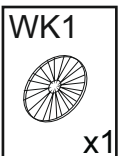
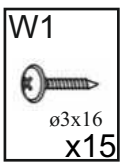
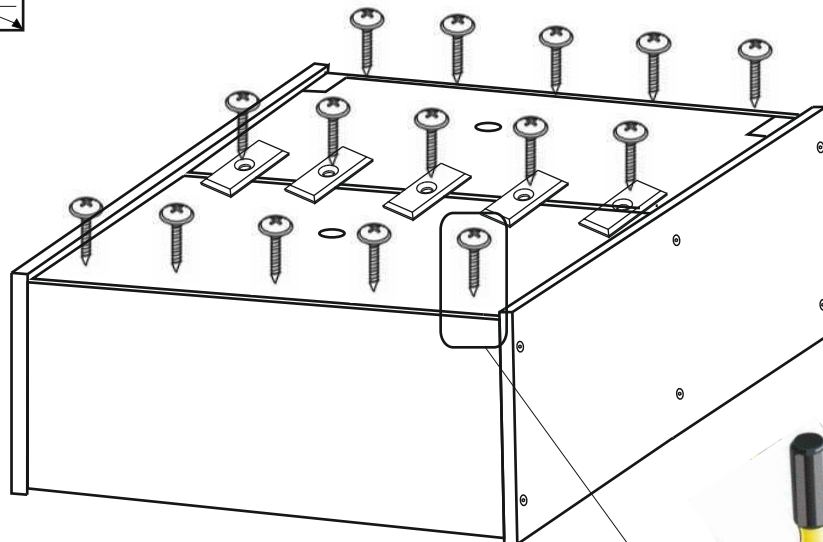
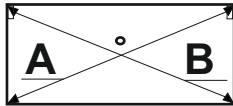

09

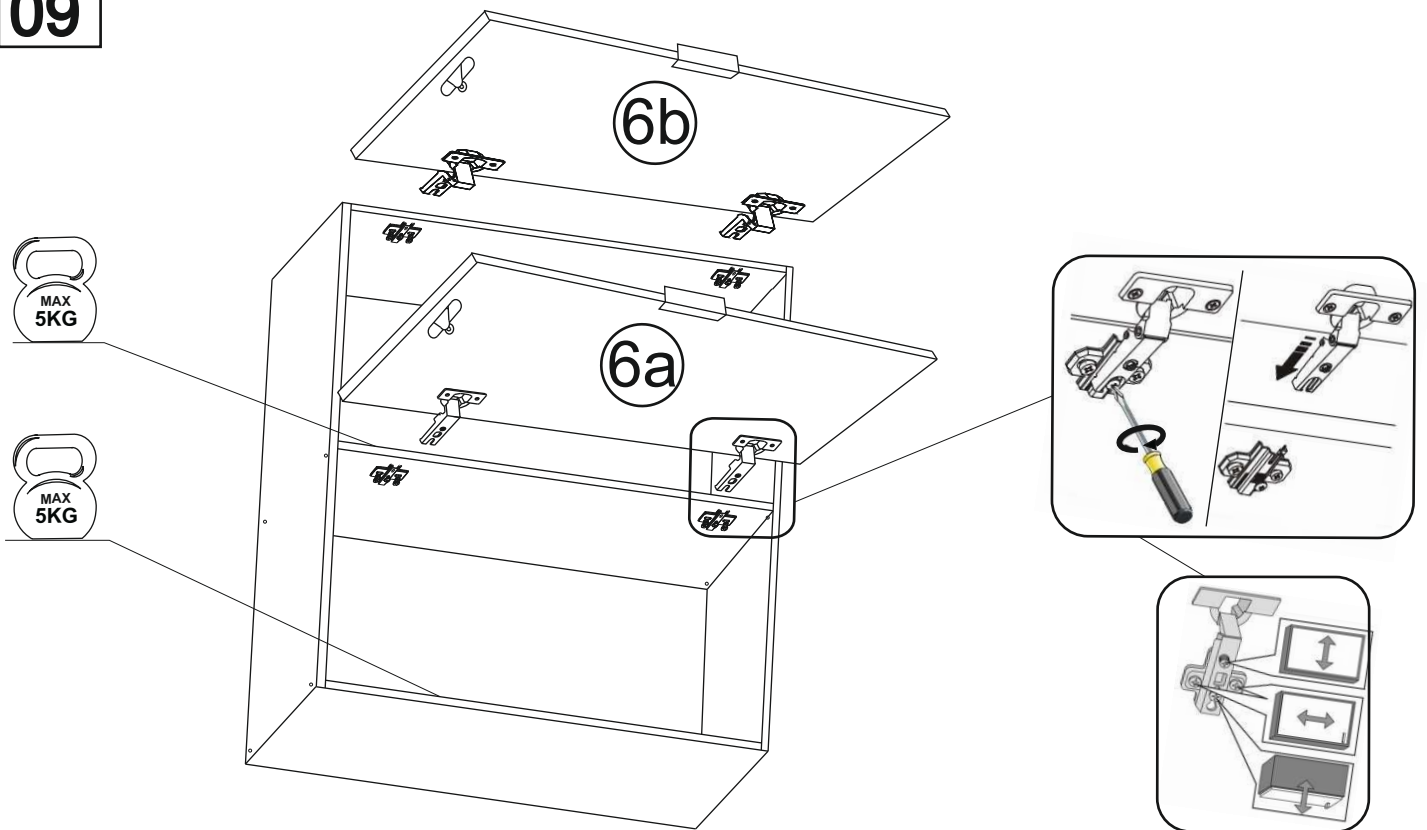

10

