

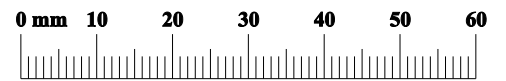

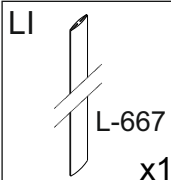

1/1	6	16x279x676	x1
	11	16x522x567	x1
	4	16x542x567	x1
	1	16x560x810	x1
	2	16x560x810	x1
	5	16x279x676	x1
	8	16x95x567	x1
	7	16x95x567	x1
	10	3x290x696	x1
	9	3x290x696	x1
	3	16x109x567	x1

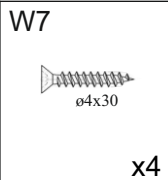
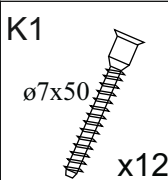
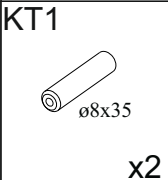
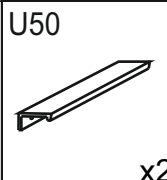
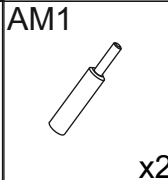
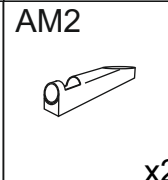

 LI L-667 x1		 W7 ø4x30 x4		 K1 ø7x50 x12		 KT1 ø8x35 x2		 U50 x2		 AM1 x2		 AM2 x2	
 W4 ø4x13 x8		 SG2 x4		 PP x4		 WK1 x1		 W11 ø3,5x16 x8		 W1 ø3x16 x12			
 ZWP1 x4		 ZWP x4		 KK1 x1		 ZK ø11 x12							

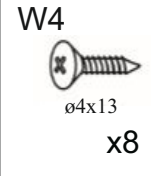
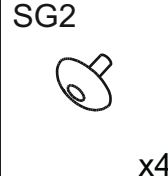
### 01

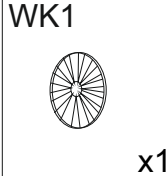
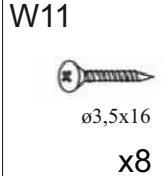
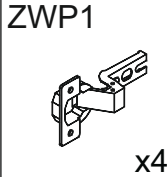
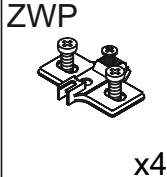
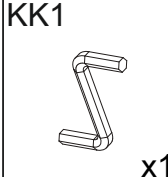
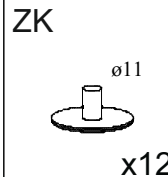
## L/R

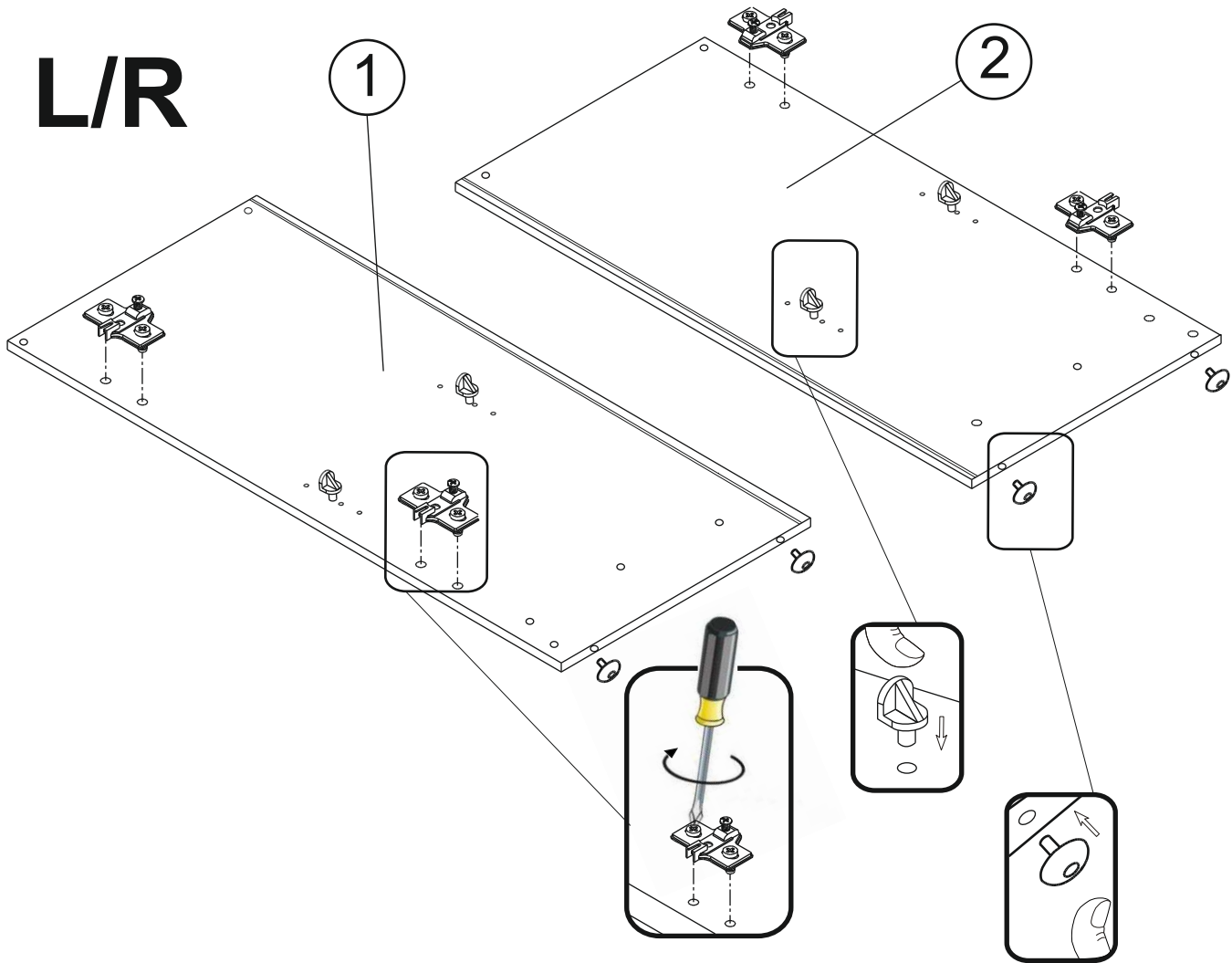

ZWP

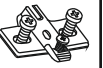

x4

PP



x4

SG2



x4

### 02

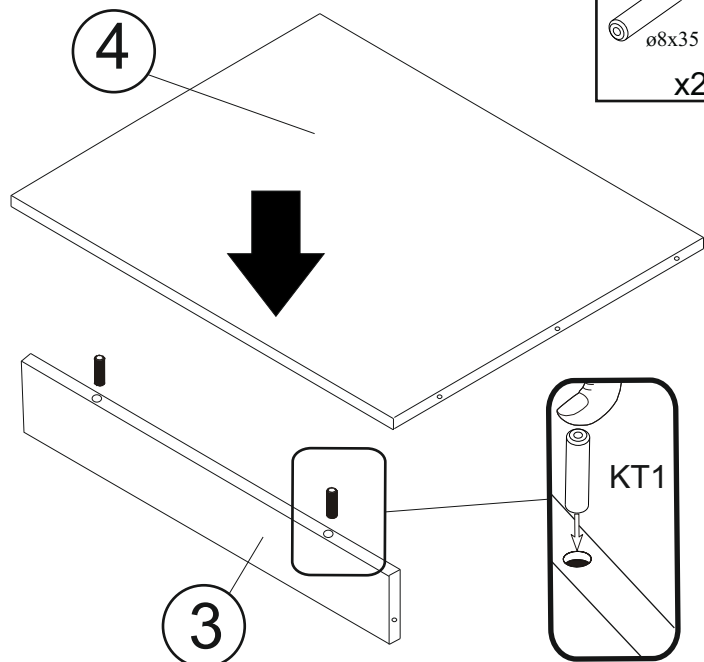

KT1

ø8x35

x2

KT1

### 03

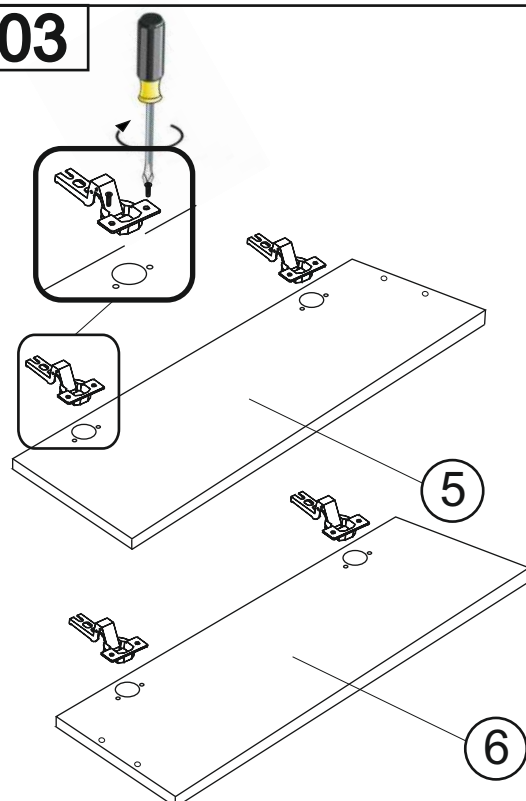

Z1



x4

W4



ø4x13

x8

04

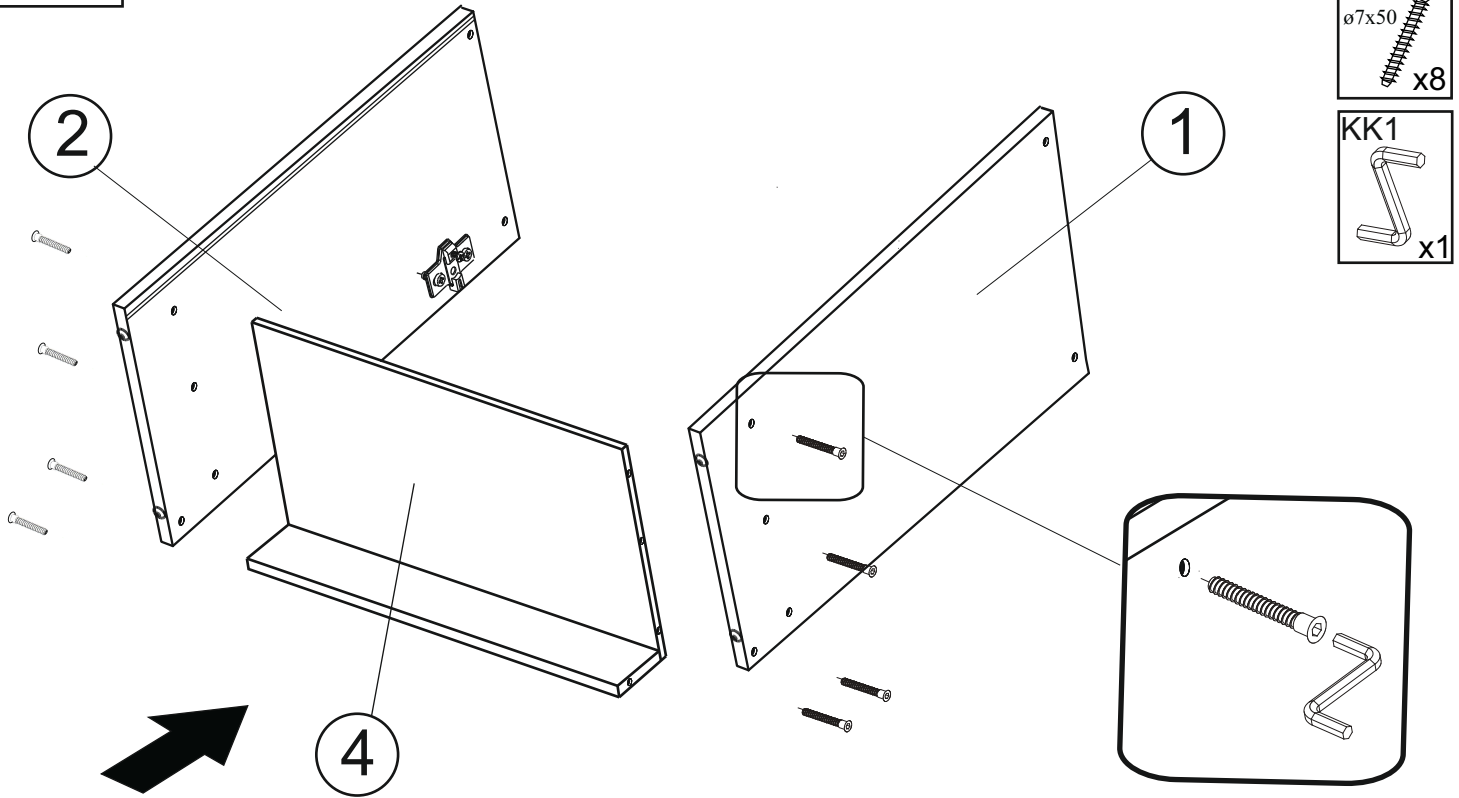

05

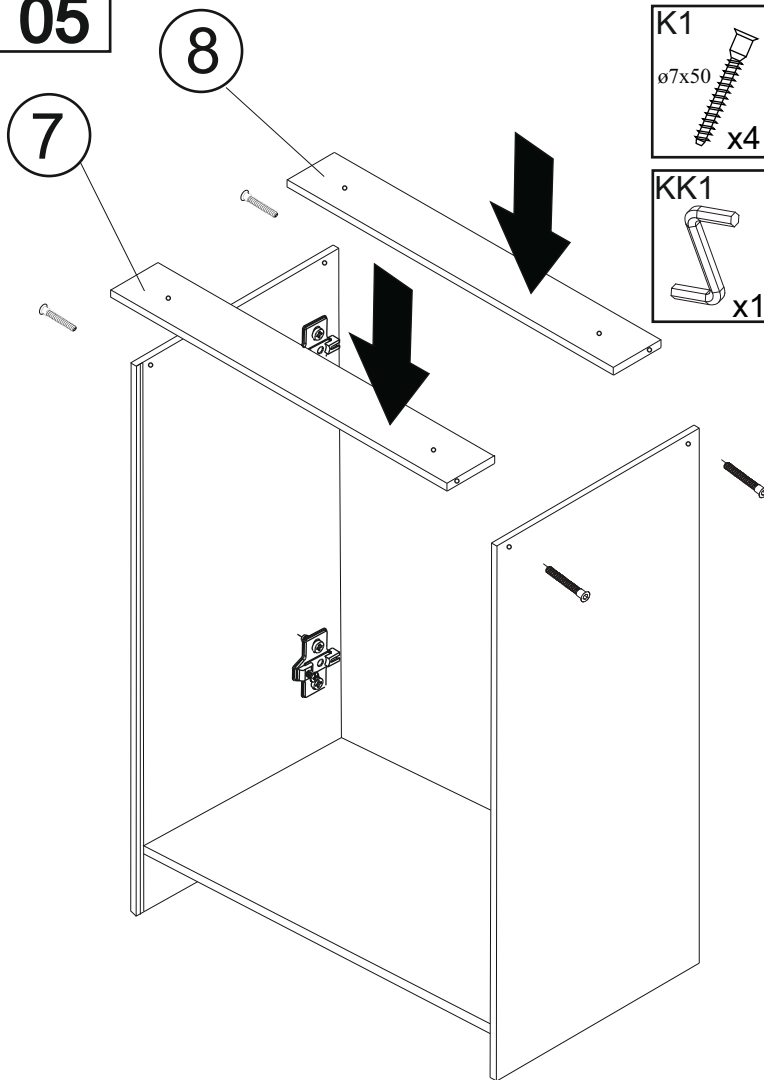

06

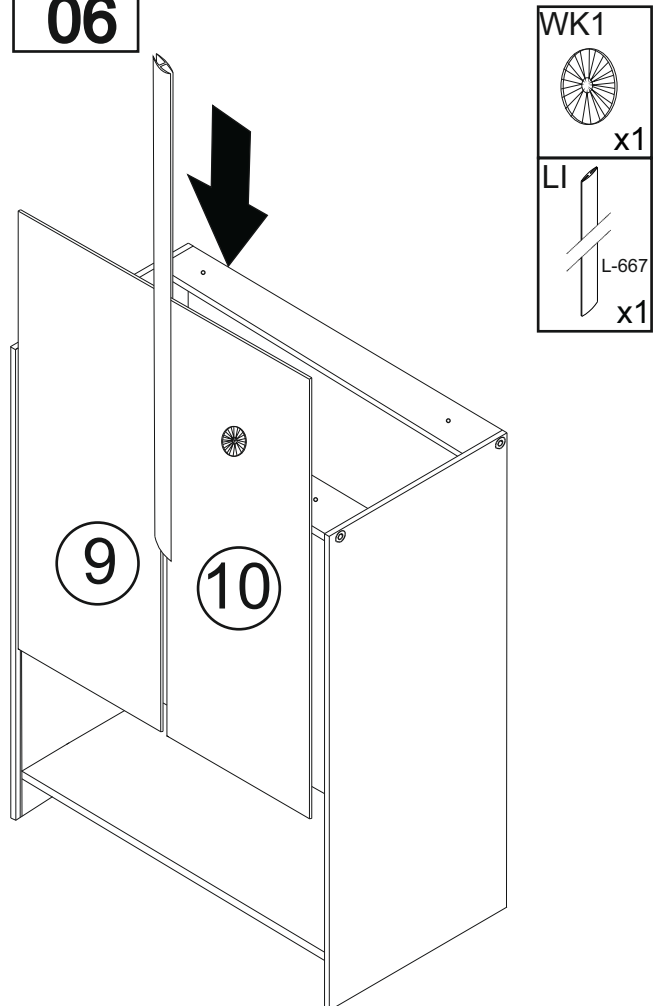

## 07

A=B

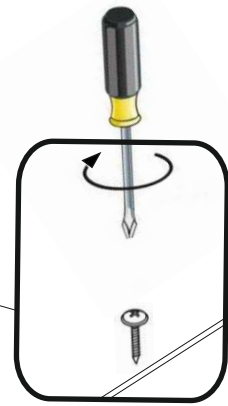
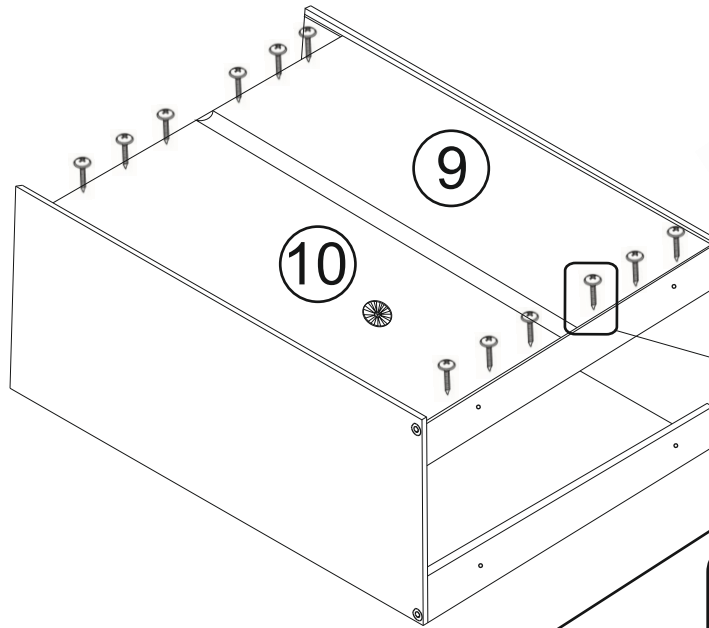
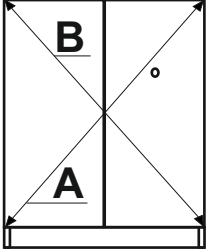

W1

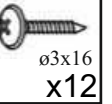

## 08

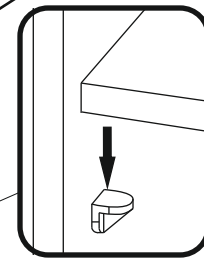
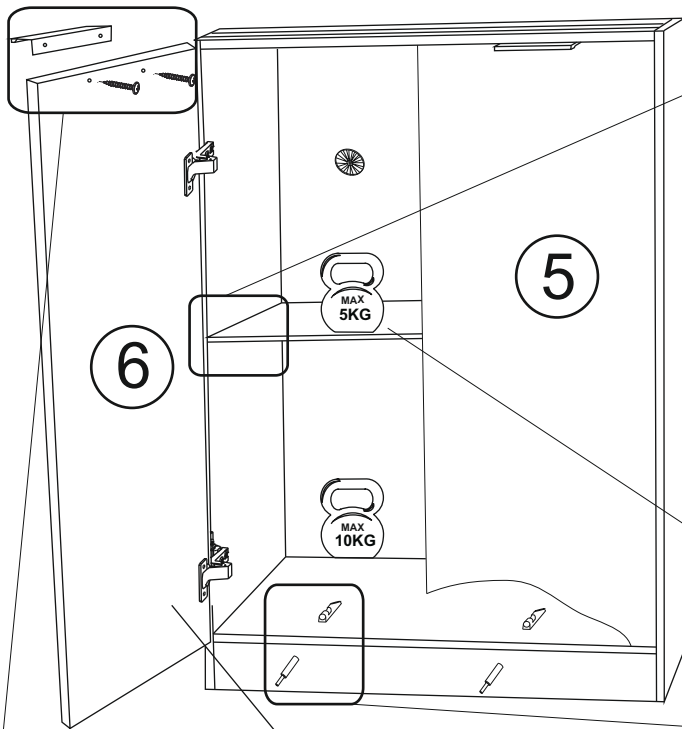

U50



AM1



AM2

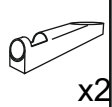

W11

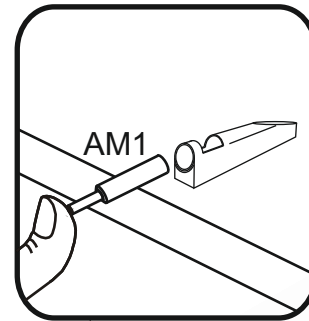
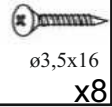

11

