

1/1	1	16x300x717	x1
	2	16x300x717	x1
	4	16x282x267	x1
	3	16x282x267	x1
	7	16x262x267	x1
	6	16x261x676	x1
	5	3x282x712	x1

K1 ø7x50 x8	LMM1 x2	W4 ø4x13 x4				
KRW1 ø8 x4	ZRS1 x2	U50 x1	AM1 x1	AM2 x1	ZWP1 x2	ZWP x2
W7 ø4x30 x4	PP x4	WK1 x1	W11 ø3,5x16 x4	W1 ø3x16 x6	KK1 x1	ZK ø11 x8

01

L/R ?

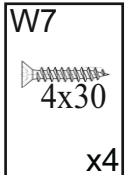
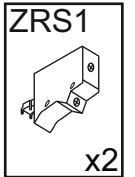
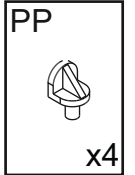
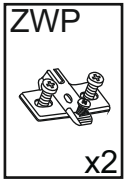
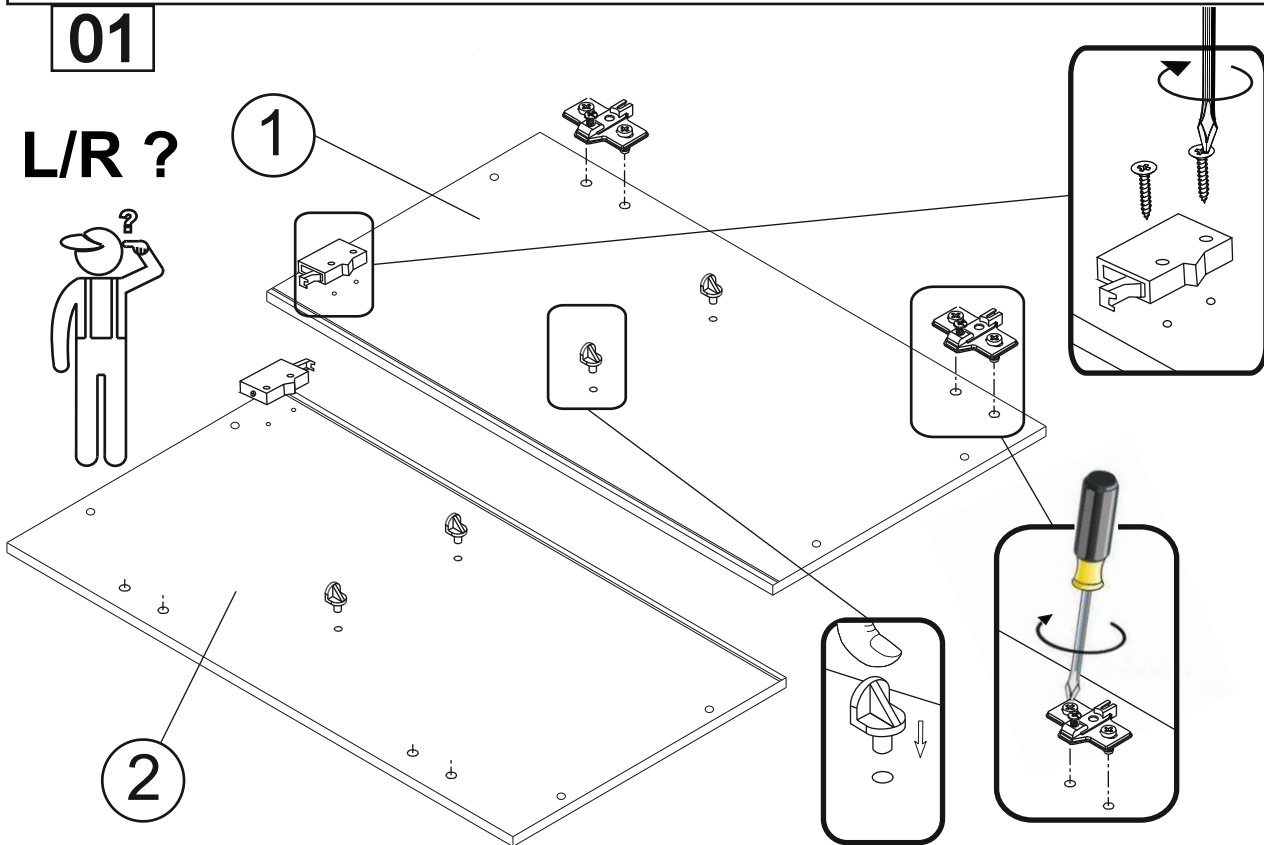

02

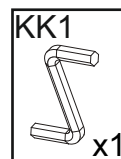
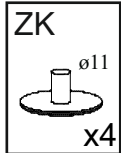
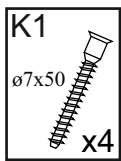
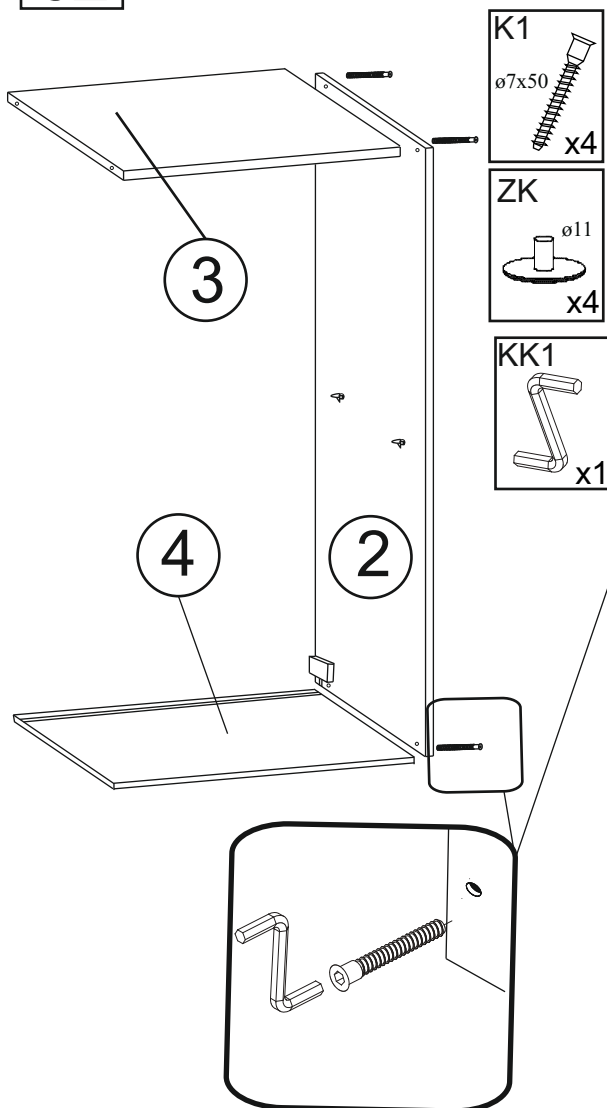

03

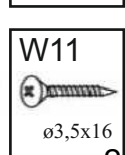
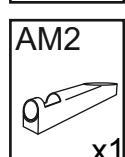
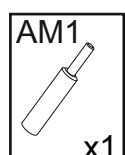
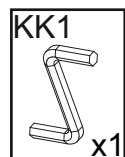
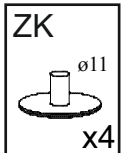
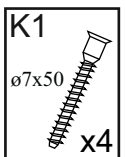
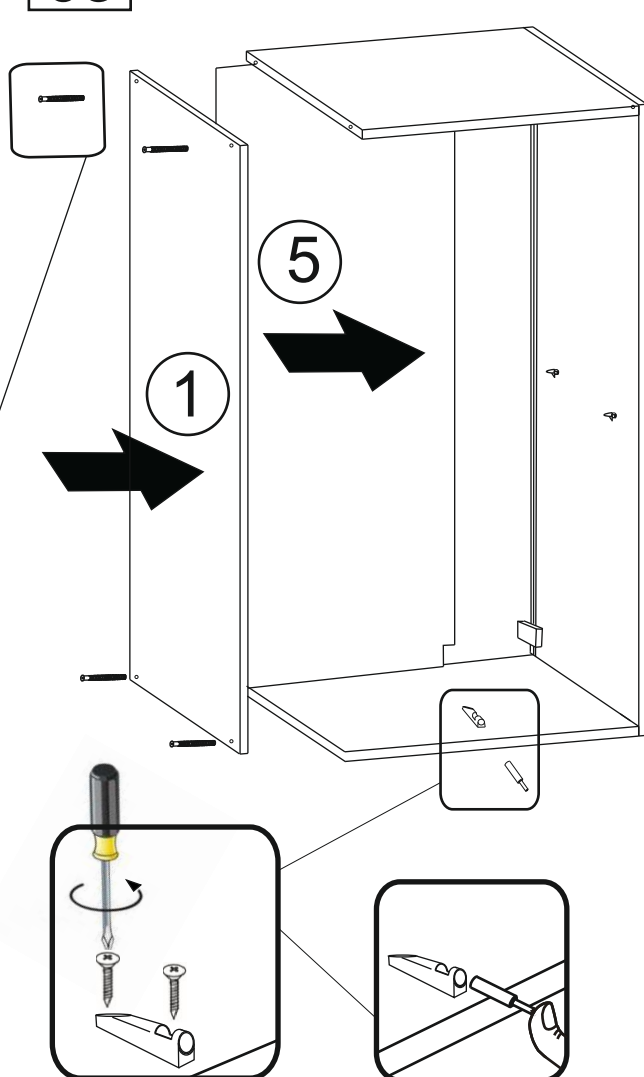

04

A=B

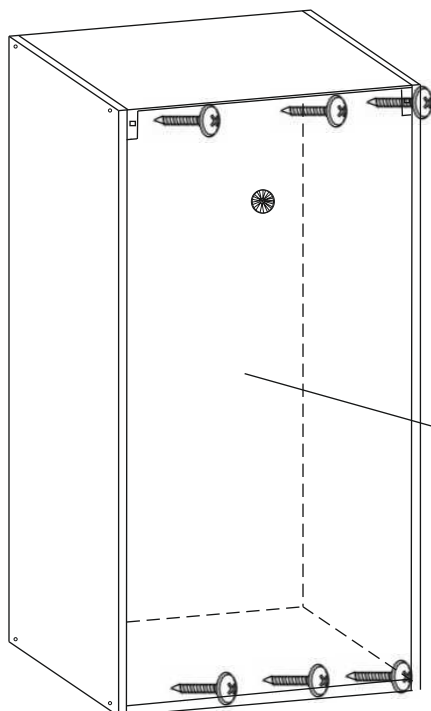
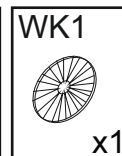
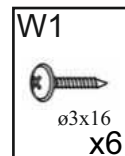
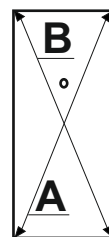

05

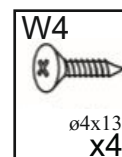
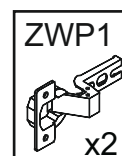
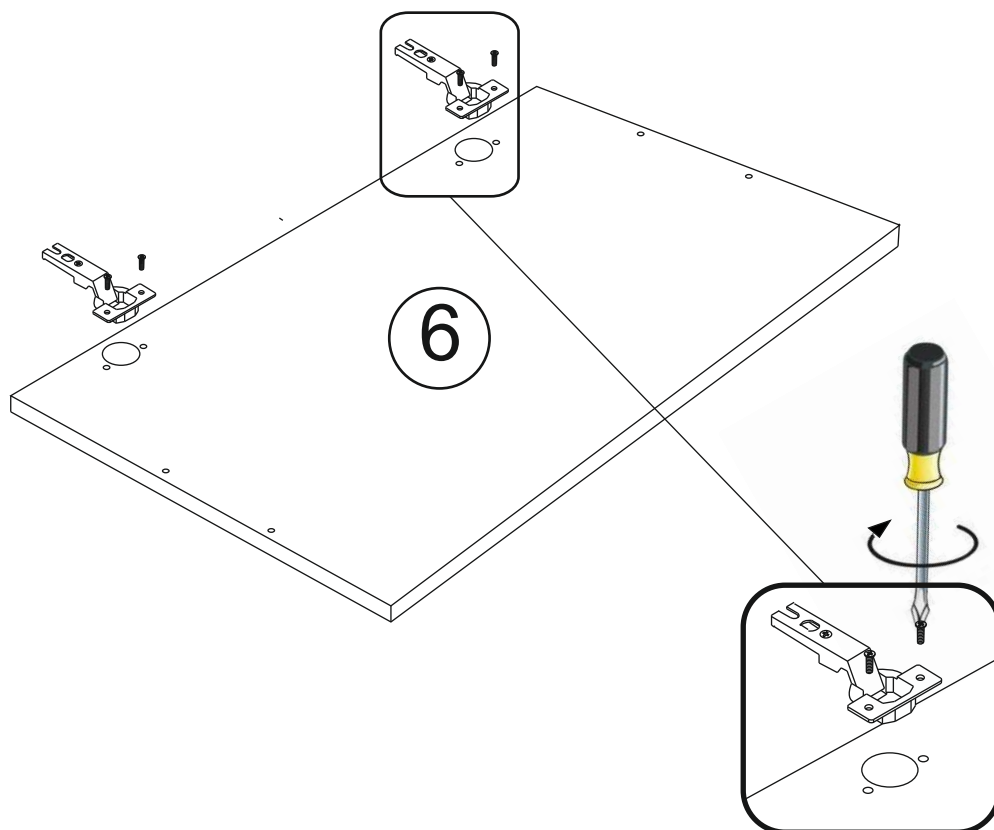

06

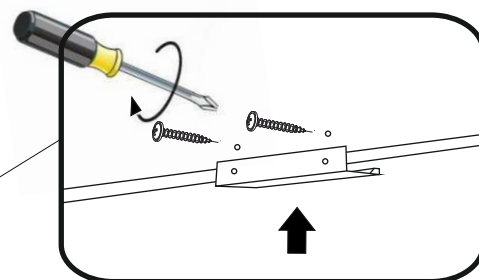
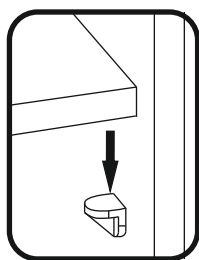
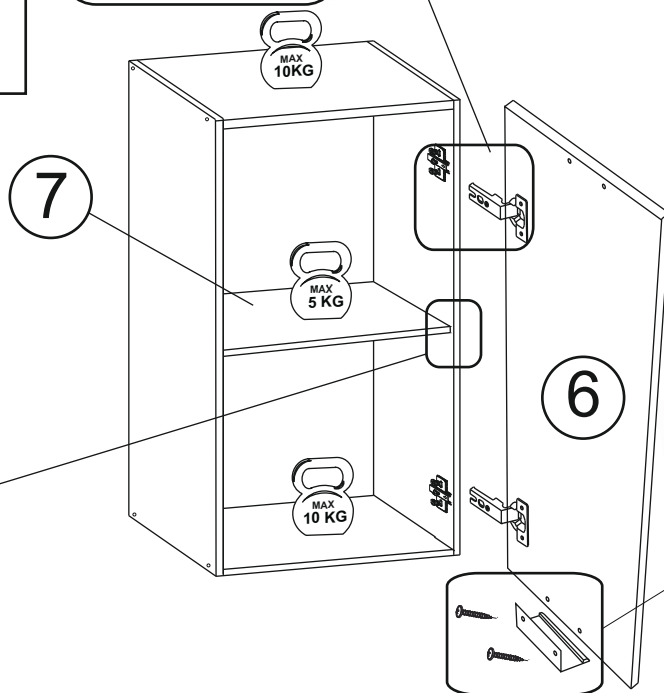
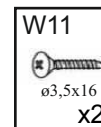
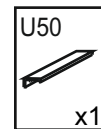
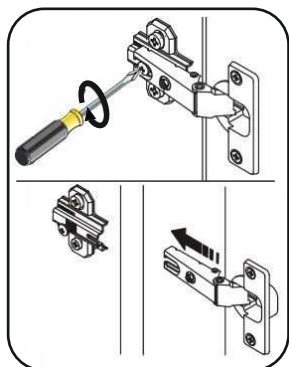
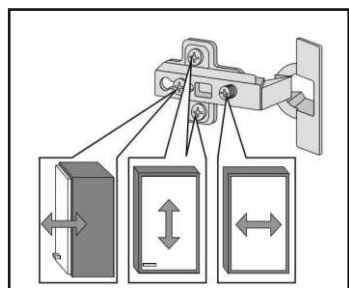

07

